

AEROEVAPORATORI A SOFFITTO

doppio flusso Tubo rigato Ø 500

Ceiling unit coolers

dual air flow rifled tube Ø 500



RIVACOLD

Tabella / Table

(A)	RDFRV1500604 RDFRV1500604ED RDFRV1500804 RDFRV1500804ED RDFRS1500604 RDFRS1500604ED	RDFRV1500608 RDFRV1500608ED RDFRV1500808 RDFRV1500808ED RDFRS1500608 RDFRS1500608ED RDFRS1500808 RDFRS1500808ED
(B)	RDFRV2500604 RDFRV2500604ED RDFRV2500804 RDFRV2500804ED RDFRS2500604 RDFRS2500604ED	RDFRV2500608 RDFRV2500608ED RDFRV2500808 RDFRV2500808ED RDFRS2500608 RDFRS2500608ED RDFRS2500808 RDFRS2500808ED
(C)	RDFRV3500604 RDFRV3500604ED RDFRV3500804 RDFRV3500804ED RDFRS3500604 RDFRS3500604ED	RDFRV3500608 RDFRV3500608ED RDFRV3500808 RDFRV3500808ED RDFRS3500608 RDFRS3500608ED RDFRS3500808 RDFRS3500808ED
(D)	RDFRV4500604 RDFRV4500604ED RDFRV4500804 RDFRV4500804ED RDFRS4500604 RDFRS4500604ED	RDFRV4500608 RDFRV4500608ED RDFRV4500808 RDFRV4500808ED RDFRS4500608 RDFRS4500608ED RDFRS4500808 RDFRS4500808ED



Aeroevaporatori a soffitto RDFR

doppio flusso Ø 500

RDFR Ceiling unit coolers

dual air flow Ø 500

Caratteristiche generali

Gli aeroevaporatori della serie RDFR sono stati ideati per essere installati in celle frigorifere per la conservazione di prodotti freschi e congelati progettati principalmente per sale di lavorazione.

La caratteristica principale di questa gamma è quella di gettare aria da entrambi i lati; questo consente il posizionamento dell'evaporatore al centro della cella favorendo un ricircolo dell'aria uniforme a vantaggio di un'ottima conservazione del prodotto.

La gamma RDFR è disponibile con due differenti passi alette (4mm, 8mm) ciascuna comprende 2 diversi numeri di ranghi, ognuno specifico a seconda dell'applicazione richiesta. Tutti i modelli sono realizzati con geometria 37,5 x 32,5 e tubo da 12mm rigato. La gamma utilizza motoventilatori a 4 e 6 poli, entrambi a due velocità utilizzabili a seconda dell'applicazione richiesta.

La serie ED, fornita di resistenze di sbrinamento già montate, è adatta per essere utilizzata alle basse temperature.

General features

RDFR range unit coolers have been designed to be installed inside cold rooms suited for fresh and frozen goods storage designed mainly for food preparation areas. The main feature of this range is of throwing air from both sides; this allow the unit cooler to be placed in the middle of the cold room ceiling giving a uniform air flow and, as a result, the best product conservation.

RDFR range is available in two different types of fin spacing (4mm, 8mm) each of them includes 2 different rows according to the needed application. All models are made with a geometry of 37,5x32,5 12mm rifled tube.

The range is fitted with 4 and 6 poles fan motors, each of them functioning at two speeds that can be used according to the need application. The ED range supplied with fitted defrosting, heaters is suitable for being used at low temperature applications.

Optional - *Optional items*

- Batteria verniciata
Varnished coil
- Resistenza per il tubo di scarico con alimentazione elettrica 220V/1/50Hz (per alimentazioni differenti contattare il nostro ufficio tecnico)
Drainage pipe heater of 220V/1/50Hz voltage (for different voltages please contact our technical dept)

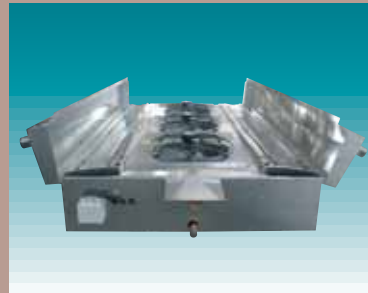

lato collegamento frigorifero ed elettrico.

model: pipe and electrical connection side.

Manufacturing features

Batteria

La batteria è costruita con alette in alluminio, tubo in rame da 12 mm rigato e geometria 37,5 x 32,5.

Gli RDFR si suddividono in 2 gruppi, ognuno specifico a seconda della temperatura cella richiesta (Tc):
passo alette 4mm per Tc da -5°C a +15°C; passo alette 8mm per Tc da -35°C a +4°C. Ogni gruppo è a sua volta disponibile con 6 e 8 ranghi.

La batteria viene collaudata con azoto ad una pressione di 25 bar.

Motoventilatori

I motoventilatori utilizzati hanno le seguenti caratteristiche:

V_ motoventilatori 4 poli

- doppia velocità (1300-1025 Rpm)
- costruito nel rispetto delle norme EN 60335-1, con protezione termica interna
- diametro ventola 500mm, rotore esterno
- alimentazione 400V/3/50Hz con possibilità di collegamento DELTA (1300 Rpm) e STAR (1025 Rpm)
- grado di protezione IP54
- classe di isolamento F
- temperatura di funzionamento da -40°C a +40°C
- non cablato
- esecuzione elettrica conforme alla direttiva 2006/95/CE Bassa Tensione

S_ motoventilatori 6 poli

- doppia velocità (870-590 Rpm)
- costruito nel rispetto delle norme EN 60335-1, con protezione termica interna
- diametro ventola 500mm, rotore esterno
- alimentazione 400V/3/50Hz con possibilità di collegamento DELTA (870 Rpm) e STAR (590 Rpm)
- grado di protezione IP54
- classe di isolamento F
- temperatura di funzionamento da -40°C a +40°C
- non cablato
- esecuzione elettrica conforme alla direttiva 2006/95/CE Bassa Tensione

Carenatura

È realizzata in alluminio. Le soluzioni costruttive adottate conferiscono robustezza alla carenatura e garantiscono l'assenza di vibrazioni durante il funzionamento. Le viti, le rondelle e i dadi sono di acciaio inossidabile.

Coil

The coil is made of aluminium fins, 12 mm rifled copper tube and a geometry of 37,5 x 32,5.

RDFR unit coolers can be classified in two groups according to the needed cold room temperature (Tc):
4mm fin spacing for a Tc from -5°C to +15°C; 8mm fin spacing for a Tc from -35°C to +4°C. Each fin spacing group is also available with 6 and 8 rows.

The coils is tested with nitrogen at a pressure of 25 bar.

Fan motors

The fan motor model in use have the following features:

V_ 4 poles fan motor

- double speed (1300 - 1025 Rpm)
- manufactured following EN 60335-1 laws, with internal thermal protection
- fan diameter 500mm, external rotor
- power supply 400V/3/50Hz with two different wiring options: DELTA (1300 RPM) and STAR (1025 RPM)
- IP54 protection rate
- F insulation class
- operating temperature from -40°C to +40°C
- not wired
- electrics made in conformity with 2006/95/CE Low Voltage directive

S_ 6 poles fan motor

- double speed (870 - 590 Rpm)
- manufactured following EN 60335-1 laws, with internal thermal protection
- fan diameter 500mm, external rotor
- power supply 400V/3/50Hz with two different wiring options: DELTA (870 RPM) and STAR (590 RPM)
- IP54 protection rate
- F insulation class
- operating temperature from -40°C to +40°C
- not wired
- electrics made in conformity with 2006/95/CE Low Voltage directive

Housing

The housing is made of aluminium. The manufacturing solutions used give the housing strength and guarantee the absence of vibrations during the functioning. Screws, washers and nuts are made of stainless steel.

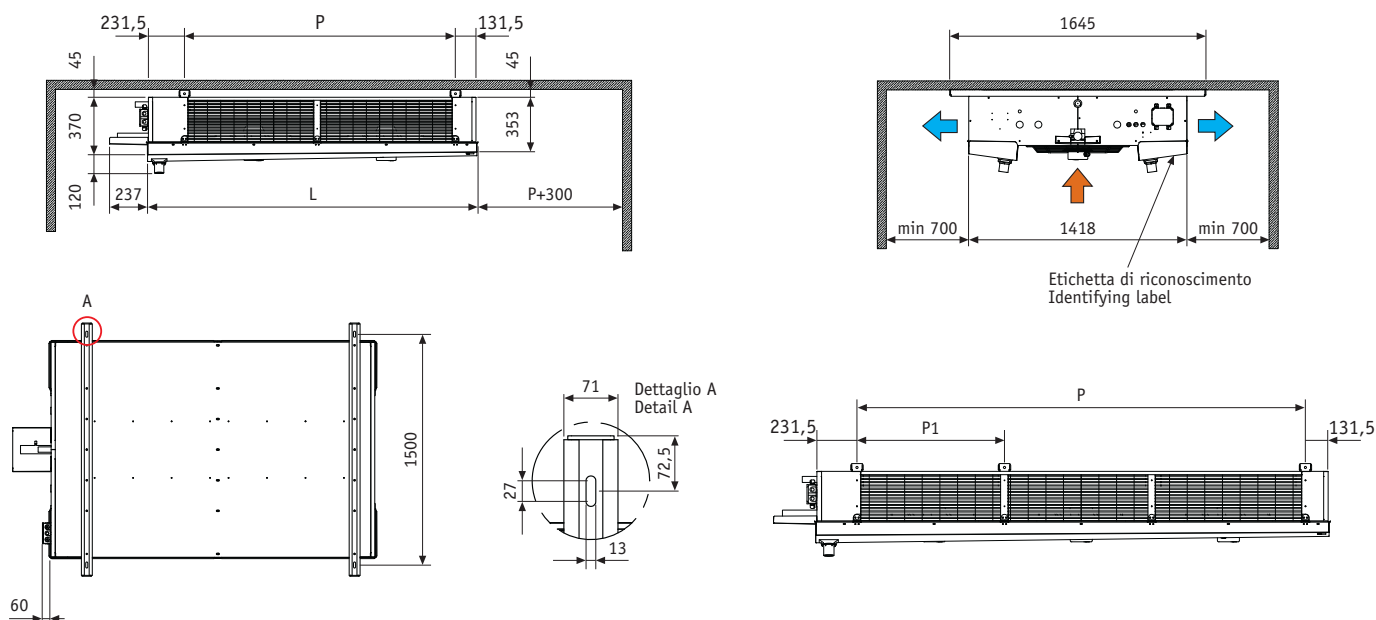

Serie RDFR / RDFR Range

Modello Model	RDFR	V1500604	V1500604ED	V1500804	V1500804ED	V2500604	V2500604ED	V2500804	V2500804ED
		S1500604	S1500604ED	S1500808	S1500808ED	S2500604	S2500604ED	S2500808	S2500808ED
Dimensioni Dimensions (mm)	P	890		890		1740		1740	
	P1	---		---		---		---	
	L	1279		1279		2129		2129	
Attacchi Connections	Ø ingresso - Ø inlet	22x1mm		22x1mm		28x1,5mm		35x1,5mm	
	Ø uscita - Ø outlet	35x1,5mm		35x1,5mm		42x1,5mm		54x2mm	
	Ø scarico - Ø drain	2x2" GAS		2x2" GAS		2x2" GAS		2x2" GAS	

Serie RDFR / RDFR Range

Modello Model	RDFR	V3500604	V3500604ED	V3500804	V3500804ED	V4500604	V4500604ED	V4500804	V4500804ED
		S3500604	S3500604ED	S3500808	S3500808ED	S4500604	S4500604ED	S4500808	S4500808ED
Dimensioni Dimensions (mm)	P	2590		2590		3440		3440	
	P1	852		852		1702		1702	
	L	2979		2979		3829		3829	
Attacchi Connections	Ø ingresso - Ø inlet	35x1,5mm		35x1,5mm		35x1,5mm		35x1,5mm	
	Ø uscita - Ø outlet	54x2mm		67x2,5mm		54x2mm		67x2,5mm	
	Ø scarico - Ø drain	2x2" GAS		2x2" GAS		2x2" GAS		2x2" GAS	

Technical features

Serie RDFR / RDFR Range		Motore S_ 6 poli bassa velocità / Motor S_ 6 poles low speed (590 Rpm)				4 mm	Passo alette / Fin spacing
Modello Model	RDFR	S1500604 S1500604ED	S2500604 S2500604ED	S3500604 S3500604ED	S4500604 S4500604ED		
Capacità $\Delta T 10$ T. cella +2°C Capacity $\Delta T 10$ Room T. +2°C	kW	9,78	19,66	29,62	37,50		
Portata d'aria Air flow	m ³ /h	2754,0	5507,5	8261,5	11015,0		
Freccia d'aria Air throw	m	7	8	9	11		
Superficie totale Total surface	m ²	47,2	94,4	142,0	189,0		
Peso netto Net weight	vers. standard standard vers.	kg	80,0	134,6	192,7	244,4	
	vers. ED ED vers.	kg	89,4	150,6	215,4	273,8	

Serie RDFR / RDFR Range		Motore S_ 6 poli alta velocità / Motor S_ 6 poles high speed (870 Rpm)				4 mm	Passo alette / Fin spacing
Modello Model	RDFR	S1500604 S1500604ED	S2500604 S2500604ED	S3500604 S3500604ED	S4500604 S4500604ED		
Capacità $\Delta T 10$ T. cella +2°C Capacity $\Delta T 10$ Room T. +2°C	kW	13,04	26,38	39,78	48,54		
Portata d'aria Air flow	m ³ /h	4192,5	8385,0	12577,5	16770,0		
Freccia d'aria Air throw	m	11	13	15	17		
Superficie totale Total surface	m ²	47,2	94,4	142,0	189,0		
Peso netto Net weight	vers. standard standard vers.	kg	80,0	134,6	192,7	244,4	
	vers. ED ED vers.	kg	89,4	150,6	215,4	273,8	

Serie RDFR / RDFR Range		Motore V_ 4 poli bassa velocità / Motor V_ 4 poles low speed (1025 Rpm)								4 mm	Passo alette / Fin spacing
Modello Model	RDFR	V1500604 V1500604ED	V1500804 V1500804ED	V2500604 V2500604ED	V2500804 V2500804ED	V3500604 V3500604ED	V3500804 V3500804ED	V4500604 V4500604ED	V4500804 V4500804ED		
Capacità $\Delta T 10$ T. cella +2°C Capacity $\Delta T 10$ Room T. +2°C	kW	14,36	15,28	29,02	30,94	43,76	47,64	53,30	59,26		
Portata d'aria Air flow	m ³ /h	5037,5	4525,0	10075,0	9050,0	15112,5	13575,0	20150,0	18100,0		
Freccia d'aria Air throw	m	12	11	14	13	16	15	18	17		
Superficie totale Total surface	m ²	47,2	62,9	94,4	126,0	142,0	189,0	189,0	252		
Peso netto Net weight	vers. standard standard vers.	kg	81,3	88,0	137,2	151,7	196,6	220,3	249,6	280,6	
	vers. ED ED vers.	kg	90,7	97,4	153,2	167,7	219,3	243,0	279,0	310,0	

Serie RDFR / RDFR Range		Motore V_ 4 poli alta velocità / Motor V_ 4 poles high speed (1300 Rpm)								4 mm	Passo alette / Fin spacing
Modello Model	RDFR	V1500604 V1500604ED	V1500804 V1500804ED	V2500604 V2500604ED	V2500804 V2500804ED	V3500604 V3500604ED	V3500804 V3500804ED	V4500604 V4500604ED	V4500804 V4500804ED		
Capacità $\Delta T 10$ T. cella +2°C Capacity $\Delta T 10$ Room T. +2°C	kW	16,52	18,14	33,60	36,76	50,60	56,92	60,46	69,42		
Portata d'aria Air flow	m ³ /h	6556,0	5969,0	13112,5	11937,5	19669,0	17906,5	26225,0	23875		
Freccia d'aria Air throw	m	17	16	20	19	23	22	25	24		
Superficie totale Total surface	m ²	47,2	62,9	94,4	126,0	142,0	189,0	189,0	252		
Peso netto Net weight	vers. standard standard vers.	kg	81,3	88,0	137,2	151,7	196,6	220,3	249,6	280,6	
	vers. ED ED vers.	kg	90,7	97,4	153,2	167,7	219,3	243,0	279,0	310,0	

Technical features
Serie RDRF / RDRF Range

Motore S_ 6 poli bassa velocità / Motor S_ 6 poles low speed (590 Rpm)

8 mm Passo alette / Fin spacing

Modello Model	RDRF	S1500608 S1500608ED	S1500808 S1500808ED	S2500608 S2500608ED	S2500808 S2500808ED	S3500608 S3500608ED	S3500808 S3500808ED	S4500608 S4500608ED	S4500808 S4500808ED
Capacità ΔT 10 T. cella -20°C Capacity ΔT 10 Room T. -20°C	kW	6,85	7,73	13,9	15,65	20,95	24,10	25,05	29,00
Portata d'aria Air flow	m ³ /h	3424,0	3172,5	6847,5	6345,0	10271,5	9517,5	13695,0	12690,0
Freccia d'aria Air throw	m	8	7	9	8	10	9	12	11
Superficie totale Total surface	m ²	25,3	33,7	50,6	67,4	75,8	101	101	135
Peso netto Net weight	vers. standard standard vers.	kg	75,9	81,3	126,4	138,2	180,4	200,0	253,5
	vers. ED ED vers.	kg	85,3	90,7	142,4	154,2	203,1	222,7	257,4

Serie RDRF / RDRF Range

Motore S_ 6 poli alta velocità / Motor S_ 6 poles high speed (870 Rpm)

8 mm Passo alette / Fin spacing

Modello Model	RDRF	S1500608 S1500608ED	S2500608 S2500608ED	S3500608 S3500608ED	S4500608 S4500608ED
Capacità ΔT 10 T. cella -20°C Capacity ΔT 10 Room T. -20°C	kW	8,40	17,10	25,85	29,90
Portata d'aria Air flow	m ³ /h	5087,0	10174,0	15260,5	20347,5
Freccia d'aria Air throw	m	12	14	16	18
Superficie totale Total surface	m ²	25,3	50,6	75,8	101
Peso netto Net weight	vers. standard standard vers.	kg	75,9	126,4	180,4
	vers. ED ED vers.	kg	85,3	142,4	203,1

Serie RDRF / RDRF Range

Motore V_ 4 poli bassa velocità / Motor V_ 4 poles low speed (1025 Rpm)

8 mm Passo alette / Fin spacing

Modello Model	RDRF	V1500608 V1500608ED	V2500608 V2500608ED	V3500608 V3500608ED	V4500608 V4500608ED
Capacità ΔT 10 T. cella -20°C Capacity ΔT 10 Room T. -20°C	kW	9,16	18,65	28,25	32,25
Portata d'aria Air flow	m ³ /h	6062,5	12125,0	18187,5	24250,0
Freccia d'aria Air throw	m	13	15	17	19
Superficie totale Total surface	m ²	25,3	50,6	75,8	101
Peso netto Net weight	vers. standard standard vers.	kg	77,2	129,0	184,3
	vers. ED ED vers.	kg	86,6	145,0	207,0

Serie RDRF / RDRF Range

Motore V_ 4 poli alta velocità / Motor V_ 4 poles High speed (1300 Rpm)

8 mm Passo alette / Fin spacing

Modello Model	RDRF	V1500608 V1500608ED	V1500808 V1500808ED	V2500608 V2500608ED	V2500808 V2500808ED	V3500608 V3500608ED	V3500808 V3500808ED	V4500608 V4500608ED	V4500808 V4500808ED
Capacità ΔT 10 T. cella -20°C Capacity ΔT 10 Room T. -20°C	kW	10,16	11,97	20,85	24,50	31,50	38,40	35,20	43,45
Portata d'aria Air flow	m ³ /h	7732,0	7290,5	15462,5	14581,5	23194,0	21872,0	30925,0	29162,5
Freccia d'aria Air throw	m	18	17	21	20	24	23	26	25
Superficie totale Total surface	m ²	25,3	33,7	50,6	67,4	75,8	101	101	135
Peso netto Net weight	vers. standard standard vers.	kg	77,2	82,6	129,0	140,8	184,3	203,9	233,2
	vers. ED ED vers.	kg	86,6	92,0	145,0	156,8	207,0	226,6	262,6

Manufacturing features

Serie RDFR / RDFR Range Ø 500

Modello Model	RDFR	V1500604 V1500604ED V1500608 V1500608ED S1500604 S1500604ED S1500608 S1500608ED	V1500804 V1500804ED	V1500808 V1500808ED	S1500808 S1500808ED	V2500604 V2500604ED V2500608 V2500608ED S2500604 S2500604ED S2500608 S2500608ED	V2500804 V2500804ED	V2500808 V2500808ED	S2500808 S2500808ED
Volume circuito evaporatore Unit cooler volume circuit	dm ³	10,4	13,0	13,0	13,0	20,1	25,1	25,1	25,1
Motoventilatori Fan motors	n x Ø mm	1x500	1x500	1x500	1x500	2x500	2x500	2x500	2x500
Assorbimento motori (*) Motor power consumption	rpm 1300	A 1,70	1,70	1,70	-	3,40	3,40	3,40	-
Motore V_ 4 poli - Motor V_ 4 poles	W	770	770	770	-	1540	1540	1540	-
Assorbimento motori (*) Motor power consumption	rpm 1025	A 0,84	0,84	-	-	1,68	1,68	-	-
Motore V_ 4 poli - Motor V_ 4 poles	W	490	490	-	-	980	980	-	-
Assorbimento motori (*) Motor power consumption	rpm 870	A 0,74	-	-	-	1,48	-	-	-
Motore S_ 6 poli - Motor S_ 6 poles	W	290	-	-	-	580	-	-	-
Assorbimento motori (*) Motor power consumption	rpm 590	A 0,36	-	-	0,36	0,72	-	-	0,72
Motore S_ 6 poli - Motor S_ 6 poles	W	150	-	-	150	300	-	-	300
Sbrinamento elettrico (*) Electrical defrost	W	5600	5600	5600	5600	10400	10400	10400	10400

(*) Alimentazione elettrica: motoventilatori 400V/3/50Hz, sbrinamento elettrico predisposto per 400/3/50Hz
Power supply : fan motors 400V/3/50Hz, electrical defrost preset for 400V/3/50Hz

Serie RDFR / RDFR Range Ø 500

Modello Model	RDFR	V3500604 V3500604ED V3500608 V3500608ED S3500604 S3500604ED S3500608 S3500608ED	V3500804 V3500804ED	V3500808 V3500808ED	S3500808 S3500808ED	V4500604 V4500604ED V4500608 V4500608ED S4500604 S4500604ED S4500608 S4500608ED	V4500804 V4500804ED	V4500808 V4500808ED	S4500808 S4500808ED
Volume circuito evaporatore Unit cooler volume circuit	dm ³	29,8	39,7	39,7	39,7	39,5	52,7	52,7	52,7
Motoventilatori Fan motors	n x Ø mm	3x500	3x500	3x500	3x500	4x500	4x500	4x500	4x500
Assorbimento motori (*) Motor power consumption	rpm 1300	A 5,10	5,10	5,10	-	6,80	6,80	6,80	-
Motore V_ 4 poli - Motor V_ 4 poles	W	2310	2310	2310	-	3080	3080	3080	-
Assorbimento motori (*) Motor power consumption	rpm 1025	A 2,52	2,52	-	-	3,36	3,36	-	-
Motore V_ 4 poli - Motor V_ 4 poles	W	1470	1470	-	-	1960	1960	-	-
Assorbimento motori (*) Motor power consumption	rpm 870	A 2,22	-	-	-	2,96	-	-	-
Motore S_ 6 poli - Motor S_ 6 poles	W	870	-	-	-	1160	-	-	-
Assorbimento motori (*) Motor power consumption	rpm 590	A 1,08	-	-	1,08	1,44	-	-	1,44
Motore S_ 6 poli - Motor S_ 6 poles	W	450	-	-	450	600	-	-	600
Sbrinamento elettrico (*) Electrical defrost	W	15040	15040	15040	15040	19840	19840	19840	19840

(*) Alimentazione elettrica: motoventilatori 400V/3/50Hz, sbrinamento elettrico predisposto per 400/3/50Hz
Power supply : fan motors 400V/3/50Hz, electrical defrost preset for 400V/3/50Hz

Model choice

Per una corretta scelta dell'evaporatore, utilizzare le tabelle "potenza frigorifera". Nelle tabelle vengono riportate le rese frigorifere calcolate per un range di temperatura cella (T_c) che varia in funzione del passo alette e della velocità del motoventilatore. Per ogni passo alette si consiglia la seguente applicazione: passo alette 4 mm, utilizzo ad una $T_c \geq +2^\circ\text{C}$; passo alette 8 mm, utilizzo ad una temperatura cella $\geq -35^\circ\text{C}$. Inoltre tali rese vengono calcolate in funzione di un ΔT (differenza tra la temperatura dell'aria in entrata e la temperatura di evaporazione del refrigerante) che va da 5°C a 10°C , utilizzando come refrigerante il gas R404A.

Impiegando altri refrigeranti, la capacità va moltiplicata per il fattore correttivo di seguito riportato: R134a=0,91; R507/R404A=1.

I parametri per la scelta dell'evaporatore sono: la temperatura della cella, il valore ΔT ed il carico termico. Nella colonna corrispondente alla temperatura cella desiderata, sceglieremo il modello che in corrispondenza del ΔT richiesto, avrà una resa uguale o superiore al carico termico.

For a correct choice of the unit cooler, use the "refrigerating output" tables.

In these tables are quoted the refrigerating capacities calculated for a cold room temperature (T_c) that changes according to the, fin spacing and the motor fan speed of the unit cooler. For each different type of fin spacing we recommend to use the following applications: 4 mm fin spacing, $T_c \geq +2^\circ\text{C}$; 8 mm fin spacing, $T_c \geq -35^\circ\text{C}$. Those capacities are calculated on the base of a ΔT value (i.e. difference between the inlet air temperature and the gas evaporating temperature) from 5°C to 10°C , by using R404A gas.

In case of a different gas in use, the capacity is to be multiplied by the relevant corrective factor: R134a = 0,91; R507/R404A = 1.

The parameters valid for the unit cooler choice are the following ones: the cold room temperature, the ΔT value and the heat load.

In the column corresponding to the requested cold room temperature we will choose the model that, matching the line of the requested ΔT , will have a capacity equal or bigger than the heat load.

Dimensione imballo
Package dimensions

Codice Code	Dimensione imballo evaporatore Evaporator package dimensions			
	A mm	B mm	H mm	Peso Weight Kg
RDFR_150 ..	1650	1708	730	51,5
RDFR_250 ..	2500	1708	730	72,8
RDFR_350 ..	3350	1708	730	106,8
RDFR_450 ..	4200	1708	730	119,3

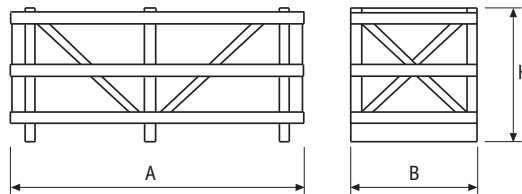

Refrigerating output

Motore S_ 6 poli bassa velocità / Motor S_ 6 poles low speed (590 Rpm)

RDFRS1500604 RDFRS1500604ED

4 mm Passo alette / Fin spacing - 6 Numero ranghi / Rows number

Tc			-5°C(*)	0°C(*)	2°C	4°C	6°C	8°C	10°C	12°C	15°C
ΔT 10	UR/RH 76%	kW	8,98	9,60	9,78	9,96	10,14	10,32	10,50	10,80	11,25
ΔT 9	UR/RH 79%	kW	8,22	8,81	8,98	9,16	9,33	9,51	9,68	9,95	10,36
ΔT 8	UR/RH 82%	kW	7,43	7,98	8,14	8,31	8,47	8,64	8,80	9,07	9,48
ΔT 7	UR/RH 85%	kW	6,62	7,12	7,28	7,43	7,59	7,74	7,90	8,14	8,50
ΔT 6	UR/RH 89%	kW	5,69	6,16	6,31	6,47	6,62	6,78	6,93	7,17	7,53
ΔT 5	UR/RH 93%	kW	4,88	5,33	5,48	5,63	5,79	5,94	6,09	6,34	6,72

Motore S_ 6 poli bassa velocità / Motor S_ 6 poles low speed (590 Rpm)

RDFRS2500604 RDFRS2500604ED

4 mm Passo alette / Fin spacing - 6 Numero ranghi / Rows number

Tc			-5°C(*)	0°C(*)	2°C	4°C	6°C	8°C	10°C	12°C	15°C
ΔT 10	UR/RH 76%	kW	18,10	19,30	19,66	20,02	20,38	20,74	21,10	21,70	22,60
ΔT 9	UR/RH 79%	kW	16,60	17,70	18,04	18,38	18,72	19,06	19,40	20,00	20,90
ΔT 8	UR/RH 82%	kW	15,00	16,10	16,42	16,74	17,06	17,38	17,70	18,20	18,95
ΔT 7	UR/RH 85%	kW	13,30	14,30	14,60	14,90	15,20	15,50	15,80	16,30	17,05
ΔT 6	UR/RH 89%	kW	11,40	12,40	12,70	13,00	13,30	13,60	13,90	14,40	15,15
ΔT 5	UR/RH 93%	kW	9,80	10,70	11,00	11,30	11,60	11,90	12,20	12,70	13,45

Motore S_ 6 poli bassa velocità / Motor S_ 6 poles low speed (590 Rpm)

RDFRS3500604 RDFRS3500604ED

4 mm Passo alette / Fin spacing - 6 Numero ranghi / Rows number

Tc			-5°C(*)	0°C(*)	2°C	4°C	6°C	8°C	10°C	12°C	15°C
ΔT 10	UR/RH 76%	kW	27,20	29,10	29,62	30,14	30,66	31,18	31,70	32,60	33,95
ΔT 9	UR/RH 79%	kW	24,90	26,70	27,20	27,70	28,20	28,70	29,20	30,00	31,20
ΔT 8	UR/RH 82%	kW	22,50	24,10	24,58	25,06	25,54	26,02	26,50	27,30	28,50
ΔT 7	UR/RH 85%	kW	20,00	21,50	21,96	22,42	22,88	23,34	23,80	24,50	25,55
ΔT 6	UR/RH 89%	kW	17,20	18,60	19,04	19,48	19,92	20,36	20,80	21,60	22,80
ΔT 5	UR/RH 93%	kW	14,70	16,10	16,54	16,98	17,42	17,86	18,30	19,10	20,30

Motore S_ 6 poli bassa velocità / Motor S_ 6 poles low speed (590 Rpm)

RDFRS4500604 RDFRS4500604ED

4 mm Passo alette / Fin spacing - 6 Numero ranghi / Rows number

Tc			-5°C(*)	0°C(*)	2°C	4°C	6°C	8°C	10°C	12°C	15°C
ΔT 10	UR/RH 76%	kW	34,00	36,70	37,50	38,30	39,10	39,90	40,70	42,00	43,95
ΔT 9	UR/RH 79%	kW	31,30	33,90	34,66	35,42	36,18	36,94	37,70	38,80	40,45
ΔT 8	UR/RH 82%	kW	28,50	30,80	31,52	32,24	32,96	33,68	34,40	35,50	37,15
ΔT 7	UR/RH 85%	kW	25,50	27,60	28,26	28,92	29,58	30,24	30,90	31,90	33,40
ΔT 6	UR/RH 89%	kW	22,10	24,00	24,64	25,28	25,92	26,56	27,20	28,20	29,70
ΔT 5	UR/RH 93%	kW	19,00	20,80	21,44	22,08	22,72	23,36	24,00	25,00	26,50

Tc = temperatura cella / cold room temperature

(*) Per modelli passo alette 4mm, si consiglia un utilizzo ad una Tc ≥ +2°C - For 4 mm fin spacing models we recommend to use the application Tc ≥ +2°C

Motore S_ 6 poli alta velocità / Motor S_ 6 poles high speed (870 Rpm)
RDFRS1500604 RDFRS1500604ED

4 mm Passo alette / Fin spacing - 6 Numero ranghi / Rows number

Tc			-5°C(*)	0°C(*)	2°C	4°C	6°C	8°C	10°C	12°C	15°C
ΔT 10	UR/RH 76%	kW	12,00	12,80	13,04	13,28	13,52	13,76	14,00	14,40	15,00
ΔT 9	UR/RH 79%	kW	10,80	11,60	11,84	12,08	12,32	12,56	12,80	13,10	13,55
ΔT 8	UR/RH 82%	kW	9,82	10,50	10,72	10,94	11,16	11,38	11,60	11,90	12,35
ΔT 7	UR/RH 85%	kW	8,76	9,43	9,62	9,82	10,01	10,21	10,40	10,70	11,15
ΔT 6	UR/RH 89%	kW	7,71	8,34	8,53	8,73	8,92	9,12	9,31	9,61	10,06
ΔT 5	UR/RH 93%	kW	6,62	7,21	7,40	7,60	7,79	7,99	8,18	8,47	8,91

Motore S_ 6 poli alta velocità / Motor S_ 6 poles high speed (870 Rpm)
RDFRS2500604 RDFRS2500604ED

4 mm Passo alette / Fin spacing - 6 Numero ranghi / Rows number

Tc			-5°C(*)	0°C(*)	2°C	4°C	6°C	8°C	10°C	12°C	15°C
ΔT 10	UR/RH 76%	kW	24,20	25,90	26,38	26,86	27,34	27,82	28,30	29,00	30,05
ΔT 9	UR/RH 79%	kW	21,90	23,50	23,94	24,38	24,82	25,26	25,70	26,30	27,20
ΔT 8	UR/RH 82%	kW	19,80	21,30	21,70	22,10	22,50	22,90	23,30	23,90	24,80
ΔT 7	UR/RH 85%	kW	17,70	19,00	19,38	19,76	20,14	20,52	20,90	21,50	22,40
ΔT 6	UR/RH 89%	kW	15,60	16,80	17,18	17,56	17,94	18,32	18,70	19,30	20,20
ΔT 5	UR/RH 93%	kW	13,30	14,50	14,88	15,26	15,64	16,02	16,40	17,00	17,90

Motore S_ 6 poli alta velocità / Motor S_ 6 poles high speed (870 Rpm)
RDFRS3500604 RDFRS3500604ED

4 mm Passo alette / Fin spacing - 6 Numero ranghi / Rows number

Tc			-5°C(*)	0°C(*)	2°C	4°C	6°C	8°C	10°C	12°C	15°C
ΔT 10	UR/RH 76%	kW	36,50	39,10	39,78	40,46	41,14	41,82	42,50	43,70	45,50
ΔT 9	UR/RH 79%	kW	33,00	35,30	35,96	36,62	37,28	37,94	38,60	39,60	41,10
ΔT 8	UR/RH 82%	kW	29,90	32,00	32,60	33,20	33,80	34,40	35,00	36,00	37,50
ΔT 7	UR/RH 85%	kW	26,60	28,60	29,16	29,72	30,28	30,84	31,40	32,30	33,65
ΔT 6	UR/RH 89%	kW	23,40	25,20	25,78	26,36	26,94	27,52	28,10	29,00	30,35
ΔT 5	UR/RH 93%	kW	20,00	21,80	22,38	22,96	23,54	24,12	24,70	25,50	26,70

Motore S_ 6 poli alta velocità / Motor S_ 6 poles high speed (870 Rpm)
RDFRS4500604 RDFRS4500604ED

4 mm Passo alette / Fin spacing - 6 Numero ranghi / Rows number

Tc			-5°C(*)	0°C(*)	2°C	4°C	6°C	8°C	10°C	12°C	15°C
ΔT 10	UR/RH 76%	kW	43,50	47,30	48,54	49,78	51,02	52,26	53,50	55,10	57,50
ΔT 9	UR/RH 79%	kW	40,30	43,70	44,74	45,78	46,82	47,86	48,90	50,30	52,40
ΔT 8	UR/RH 82%	kW	36,80	39,90	40,86	41,82	42,78	43,74	44,70	46,00	47,95
ΔT 7	UR/RH 85%	kW	33,00	35,90	36,76	37,62	38,48	39,34	40,20	41,50	43,45
ΔT 6	UR/RH 89%	kW	29,30	32,00	32,84	33,68	34,52	35,36	36,20	37,40	39,20
ΔT 5	UR/RH 93%	kW	25,40	27,80	28,62	29,44	30,26	31,08	31,90	33,10	34,90

Tc = temperatura cella / cold room temperature

(*) Per modelli passo alette 4mm, si consiglia un utilizzo ad una Tc ≥ +2°C - For 4 mm fin spacing models we recommend to use the application Tc ≥ +2°C

Refrigerating output

Motore V_ 4 poli bassa velocità / Motor V_ 4 poli low speed (1025 Rpm)

RDFRV1500604 RDFRV1500604ED

4 mm Passo alette / Fin spacing - 6 Numero ranghi / Rows number

Tc			-5°C(*)	0°C(*)	2°C	4°C	6°C	8°C	10°C	12°C	15°C
ΔT 10	UR/RH 76%	kW	13,10	14,10	14,36	14,62	14,88	15,14	15,40	15,90	16,65
ΔT 9	UR/RH 79%	kW	12,10	13,00	13,24	13,48	13,72	13,96	14,20	14,60	15,20
ΔT 8	UR/RH 82%	kW	11,00	11,80	12,02	12,24	12,46	12,68	12,90	13,30	13,90
ΔT 7	UR/RH 85%	kW	9,78	10,50	10,72	10,94	11,16	11,38	11,60	11,90	12,35
ΔT 6	UR/RH 89%	kW	8,62	9,32	9,54	9,75	9,97	10,18	10,40	10,70	11,15
ΔT 5	UR/RH 93%	kW	7,41	8,05	8,26	8,48	8,69	8,91	9,12	9,43	9,90

Motore V_ 4 poli bassa velocità / Motor V_ 4 poli low speed (1025 Rpm)

RDFRV1500804 RDFRV1500804ED

4 mm Passo alette / Fin spacing - 8 Numero ranghi / Rows number

Tc			-5°C(*)	0°C(*)	2°C	4°C	6°C	8°C	10°C	12°C	15°C
ΔT 10	UR/RH 76%	kW	14,00	15,00	15,28	15,56	15,84	16,12	16,40	16,90	17,65
ΔT 9	UR/RH 79%	kW	12,90	13,80	14,08	14,36	14,64	14,92	15,20	15,60	16,20
ΔT 8	UR/RH 82%	kW	11,70	12,50	12,76	13,02	13,28	13,54	13,80	14,20	14,80
ΔT 7	UR/RH 85%	kW	10,40	11,20	11,44	11,68	11,92	12,16	12,40	12,70	13,15
ΔT 6	UR/RH 89%	kW	9,16	9,92	10,16	10,39	10,63	10,86	11,10	11,50	12,10
ΔT 5	UR/RH 93%	kW	7,88	8,57	8,81	9,05	9,28	9,52	9,76	10,10	10,61

Motore V_ 4 poli bassa velocità / Motor V_ 4 poli low speed (1025 Rpm)

RDFRV2500604 RDFRV2500604ED

4 mm Passo alette / Fin spacing - 6 Numero ranghi / Rows number

Tc			-5°C(*)	0°C(*)	2°C	4°C	6°C	8°C	10°C	12°C	15°C
ΔT 10	UR/RH 76%	kW	26,60	28,50	29,02	29,54	30,06	30,58	31,10	31,90	33,10
ΔT 9	UR/RH 79%	kW	24,40	26,20	26,70	27,20	27,70	28,20	28,70	29,40	30,45
ΔT 8	UR/RH 82%	kW	22,20	23,80	24,26	24,72	25,18	25,64	26,10	26,70	27,60
ΔT 7	UR/RH 85%	kW	19,80	21,20	21,62	22,04	22,46	22,88	23,30	24,00	25,05
ΔT 6	UR/RH 89%	kW	17,40	18,80	19,22	19,64	20,06	20,48	20,90	21,50	22,40
ΔT 5	UR/RH 93%	kW	14,90	16,20	16,62	17,04	17,46	17,88	18,30	19,00	20,05

Motore V_ 4 poli bassa velocità / Motor V_ 4 poli low speed (1025 Rpm)

RDFRV2500804 RDFRV2500804ED

4 mm Passo alette / Fin spacing - 8 Numero ranghi / Rows number

Tc			-5°C(*)	0°C(*)	2°C	4°C	6°C	8°C	10°C	12°C	15°C
ΔT 10	UR/RH 76%	kW	28,30	30,40	30,94	31,48	32,02	32,56	33,10	34,10	35,60
ΔT 9	UR/RH 79%	kW	26,00	27,90	28,42	28,94	29,46	29,98	30,50	31,40	32,75
ΔT 8	UR/RH 82%	kW	23,50	25,30	25,80	26,30	26,80	27,30	27,80	28,50	29,55
ΔT 7	UR/RH 85%	kW	21,00	22,60	23,06	23,52	23,98	24,44	24,90	25,60	26,65
ΔT 6	UR/RH 89%	kW	18,50	20,00	20,46	20,92	21,38	21,84	22,30	23,00	24,05
ΔT 5	UR/RH 93%	kW	15,80	17,30	17,76	18,22	18,68	19,14	19,60	20,30	21,35

Tc = temperatura cella / cold room temperature

(*) Per modelli passo alette 4mm, si consiglia un utilizzo ad una Tc ≥ +2°C - For 4 mm fin spacing models we recommend to use the application Tc ≥ +2°C

Motore V_ 4 poli bassa velocità / Motor V_ 4 poli low speed (1025 Rpm)
RDFRV3500604 RDFRV3500604ED

4 mm Passo alette / Fin spacing - 6 Numero ranghi / Rows number

Tc		-5°C(*)	0°C(*)	2°C	4°C	6°C	8°C	10°C	12°C	15°C
ΔT 10	UR/RH 76% kW	40,10	43,00	43,76	44,52	45,28	46,04	46,80	48,10	50,05
ΔT 9	UR/RH 79% kW	36,90	39,50	40,22	40,94	41,66	42,38	43,10	44,20	45,85
ΔT 8	UR/RH 82% kW	33,40	35,80	36,48	37,16	37,84	38,52	39,20	40,20	41,70
ΔT 7	UR/RH 85% kW	29,70	32,00	32,60	33,20	33,80	34,40	35,00	36,00	37,50
ΔT 6	UR/RH 89% kW	26,20	28,20	28,84	29,48	30,12	30,76	31,40	32,30	33,65
ΔT 5	UR/RH 93% kW	22,50	24,40	25,02	25,64	26,26	26,88	27,50	28,50	30,00

Motore V_ 4 poli bassa velocità / Motor V_ 4 poli low speed (1025 Rpm)
RDFRV3500804 RDFRV3500804ED

4 mm Passo alette / Fin spacing - 8 Numero ranghi / Rows number

Tc		-5°C(*)	0°C(*)	2°C	4°C	6°C	8°C	10°C	12°C	15°C
ΔT 10	UR/RH 76% kW	43,70	46,80	47,64	48,48	49,32	50,16	51,00	52,40	54,50
ΔT 9	UR/RH 79% kW	40,10	42,90	43,74	44,58	45,42	46,26	47,10	48,30	50,10
ΔT 8	UR/RH 82% kW	36,20	38,90	39,66	40,42	41,18	41,94	42,70	44,00	45,95
ΔT 7	UR/RH 85% kW	32,30	34,70	35,42	36,14	36,86	37,58	38,30	39,40	41,05
ΔT 6	UR/RH 89% kW	28,40	30,70	31,42	32,14	32,86	33,58	34,30	35,50	37,30
ΔT 5	UR/RH 93% kW	24,40	26,50	27,24	27,98	28,72	29,46	30,20	31,30	32,95

Motore V_ 4 poli bassa velocità / Motor V_ 4 poli low speed (1025 Rpm)
RDFRV4500604 RDFRV4500604ED

4 mm Passo alette / Fin spacing - 6 Numero ranghi / Rows number

Tc		-5°C(*)	0°C(*)	2°C	4°C	6°C	8°C	10°C	12°C	15°C
ΔT 10	UR/RH 76% kW	47,70	52,00	53,30	54,60	55,90	57,20	58,50	60,20	62,75
ΔT 9	UR/RH 79% kW	44,30	48,30	49,48	50,66	51,84	53,02	54,20	55,80	58,20
ΔT 8	UR/RH 82% kW	40,60	44,20	45,26	46,32	47,38	48,44	49,50	51,00	53,25
ΔT 7	UR/RH 85% kW	36,50	39,80	40,76	41,72	42,68	43,64	44,60	45,90	47,85
ΔT 6	UR/RH 89% kW	32,50	35,50	36,42	37,34	38,26	39,18	40,10	41,50	43,60
ΔT 5	UR/RH 93% kW	28,20	30,90	31,80	32,70	33,60	34,50	35,40	36,70	38,65

Motore V_ 4 poli bassa velocità / Motor V_ 4 poli low speed (1025 Rpm)
RDFRV4500804 RDFRV4500804ED

4 mm Passo alette / Fin spacing - 8 Numero ranghi / Rows number

Tc		-5°C(*)	0°C(*)	2°C	4°C	6°C	8°C	10°C	12°C	15°C
ΔT 10	UR/RH 76% kW	53,30	57,90	59,26	60,62	61,98	63,34	64,70	66,70	69,70
ΔT 9	UR/RH 79% kW	49,30	53,50	54,78	56,06	57,34	58,62	59,90	61,70	64,40
ΔT 8	UR/RH 82% kW	45,00	48,80	49,98	51,16	52,34	53,52	54,70	56,50	59,20
ΔT 7	UR/RH 85% kW	40,40	43,90	44,98	46,06	47,14	48,22	49,30	50,90	53,30
ΔT 6	UR/RH 89% kW	35,80	39,10	40,16	41,22	42,28	43,34	44,40	46,00	48,40
ΔT 5	UR/RH 93% kW	31,00	34,00	35,04	36,08	37,12	38,16	39,20	40,70	42,95

Tc = temperatura cella / cold room temperature

(*) Per modelli passo alette 4mm, si consiglia un utilizzo ad una Tc ≥ +2°C - For 4 mm fin spacing models we recommend to use the application Tc ≥ +2°C

Refrigerating output

Motore V_ 4 poli alta velocità / Motor V_ 4 poles high speed (1300 Rpm)

RDFRV1500604 RDFRV1500604ED

4 mm Passo alette / Fin spacing - 6 Numero ranghi / Rows number

Tc			-5°C(*)	0°C(*)	2°C	4°C	6°C	8°C	10°C	12°C	15°C
ΔT 10	UR/RH 76%	kW	15,10	16,20	16,52	16,84	17,16	17,48	17,80	18,30	19,05
ΔT 9	UR/RH 79%	kW	13,90	15,00	15,30	15,60	15,90	16,20	16,50	16,90	17,50
ΔT 8	UR/RH 82%	kW	12,60	13,60	13,88	14,16	14,44	14,72	15,00	15,40	16,00
ΔT 7	UR/RH 85%	kW	11,30	12,20	12,44	12,68	12,92	13,16	13,40	13,80	14,40
ΔT 6	UR/RH 89%	kW	9,99	10,80	11,04	11,28	11,52	11,76	12,00	12,40	13,00
ΔT 5	UR/RH 93%	kW	8,50	9,23	9,46	9,70	9,93	10,17	10,40	10,80	11,40

Motore V_ 4 poli alta velocità / Motor V_ 4 poles high speed (1300 Rpm)

RDFRV1500804 RDFRV1500804ED

4 mm Passo alette / Fin spacing - 8 Numero ranghi / Rows number

Tc			-5°C(*)	0°C(*)	2°C	4°C	6°C	8°C	10°C	12°C	15°C
ΔT 10	UR/RH 76%	kW	16,50	17,80	18,14	18,48	18,82	19,16	19,50	20,10	21,00
ΔT 9	UR/RH 79%	kW	15,20	16,40	16,72	17,04	17,36	17,68	18,00	18,50	19,25
ΔT 8	UR/RH 82%	kW	13,80	14,90	15,20	15,50	15,80	16,10	16,40	16,90	17,65
ΔT 7	UR/RH 85%	kW	12,40	13,30	13,58	13,86	14,14	14,42	14,70	15,10	15,70
ΔT 6	UR/RH 89%	kW	10,90	11,80	12,08	12,36	12,64	12,92	13,20	13,60	14,20
ΔT 5	UR/RH 93%	kW	9,38	10,20	10,48	10,76	11,04	11,32	11,60	12,00	12,60

Motore V_ 4 poli alta velocità / Motor V_ 4 poles high speed (1300 Rpm)

RDFRV2500604 RDFRV2500604ED

4 mm Passo alette / Fin spacing - 6 Numero ranghi / Rows number

Tc			-5°C(*)	0°C(*)	2°C	4°C	6°C	8°C	10°C	12°C	15°C
ΔT 10	UR/RH 76%	kW	30,70	33,00	33,60	34,20	34,80	35,40	36,00	37,00	38,50
ΔT 9	UR/RH 79%	kW	28,20	30,30	30,90	31,50	32,10	32,70	33,30	34,10	35,30
ΔT 8	UR/RH 82%	kW	25,60	27,60	28,12	28,64	29,16	29,68	30,20	31,00	32,20
ΔT 7	UR/RH 85%	kW	23,00	24,70	25,18	25,66	26,14	26,62	27,10	27,80	28,85
ΔT 6	UR/RH 89%	kW	20,20	21,80	22,28	22,76	23,24	23,72	24,20	25,00	26,20
ΔT 5	UR/RH 93%	kW	17,20	18,60	19,08	19,56	20,04	20,52	21,00	21,70	22,75

Motore V_ 4 poli alta velocità / Motor V_ 4 poles high speed (1300 Rpm)

RDFRV2500804 RDFRV2500804ED

4 mm Passo alette / Fin spacing - 8 Numero ranghi / Rows number

Tc			-5°C(*)	0°C(*)	2°C	4°C	6°C	8°C	10°C	12°C	15°C
ΔT 10	UR/RH 76%	kW	33,60	36,10	36,76	37,42	38,08	38,74	39,40	40,50	42,15
ΔT 9	UR/RH 79%	kW	30,90	33,20	33,84	34,48	35,12	35,76	36,40	37,30	38,65
ΔT 8	UR/RH 82%	kW	28,00	30,10	30,70	31,30	31,90	32,50	33,10	34,00	35,35
ΔT 7	UR/RH 85%	kW	25,00	26,90	27,44	27,98	28,52	29,06	29,60	30,50	31,85
ΔT 6	UR/RH 89%	kW	22,10	23,80	24,34	24,88	25,42	25,96	26,50	27,40	28,75
ΔT 5	UR/RH 93%	kW	18,90	20,60	21,14	21,68	22,22	22,76	23,30	24,10	25,30

Tc = temperatura cella / cold room temperature

(*) Per modelli passo alette 4mm, si consiglia un utilizzo ad una Tc ≥ +2°C - For 4 mm fin spacing models we recommend to use the application Tc ≥ +2°C

Motore V_ 4 poli alta velocità / Motor V_ 4 poles high speed (1300 Rpm)
RDFRV3500604 RDFRV3500604ED

4 mm Passo alette / Fin spacing - 6 Numero ranghi / Rows number

		Tc	-5°C(*)	0°C(*)	2°C	4°C	6°C	8°C	10°C	12°C	15°C
ΔT 10	UR/RH 76% kW		46,30	49,70	50,60	51,50	52,40	53,30	54,20	55,70	57,95
ΔT 9	UR/RH 79% kW		42,60	45,70	46,58	47,46	48,34	49,22	50,10	51,30	53,10
ΔT 8	UR/RH 82% kW		38,70	41,50	42,30	43,10	43,90	44,70	45,50	46,60	48,25
ΔT 7	UR/RH 85% kW		34,60	37,10	37,82	38,54	39,26	39,98	40,70	41,80	43,45
ΔT 6	UR/RH 89% kW		30,50	32,90	33,60	34,30	35,00	35,70	36,40	37,50	39,15
ΔT 5	UR/RH 93% kW		25,80	28,00	28,70	29,40	30,10	30,80	31,50	32,60	34,25

Motore V_ 4 poli alta velocità / Motor V_ 4 poles high speed (1300 Rpm)
RDFRV3500804 RDFRV3500804ED

4 mm Passo alette / Fin spacing - 8 Numero ranghi / Rows number

		Tc	-5°C(*)	0°C(*)	2°C	4°C	6°C	8°C	10°C	12°C	15°C
ΔT 10	UR/RH 76% kW		52,10	55,90	56,92	57,94	58,96	59,98	61,00	62,80	65,50
ΔT 9	UR/RH 79% kW		47,90	51,40	52,38	53,36	54,34	55,32	56,30	57,80	60,05
ΔT 8	UR/RH 82% kW		43,40	46,60	47,52	48,44	49,36	50,28	51,20	52,60	54,70
ΔT 7	UR/RH 85% kW		38,70	41,60	42,46	43,32	44,18	45,04	45,90	47,20	49,15
ΔT 6	UR/RH 89% kW		34,10	36,90	37,74	38,58	39,42	40,26	41,10	42,40	44,35
ΔT 5	UR/RH 93% kW		29,30	31,80	32,66	33,52	34,38	35,24	36,10	37,40	39,35

Motore V_ 4 poli alta velocità / Motor V_ 4 poles high speed (1300 Rpm)
RDFRV4500604 RDFRV4500604ED

4 mm Passo alette / Fin spacing - 6 Numero ranghi / Rows number

		Tc	-5°C(*)	0°C(*)	2°C	4°C	6°C	8°C	10°C	12°C	15°C
ΔT 10	UR/RH 76% kW		53,70	58,90	60,46	62,02	63,58	65,14	66,70	68,70	71,70
ΔT 9	UR/RH 79% kW		50,00	54,80	56,22	57,64	59,06	60,48	61,90	63,80	66,65
ΔT 8	UR/RH 82% kW		46,00	50,30	51,60	52,90	54,20	55,50	56,80	58,40	60,80
ΔT 7	UR/RH 85% kW		41,60	45,40	46,56	47,72	48,88	50,04	51,20	52,70	54,95
ΔT 6	UR/RH 89% kW		36,70	40,60	41,70	42,80	43,90	45,00	46,10	47,60	49,85
ΔT 5	UR/RH 93% kW		31,90	35,00	36,04	37,08	38,12	39,16	40,20	41,70	43,95

Motore V_ 4 poli alta velocità / Motor V_ 4 poles high speed (1300 Rpm)
RDFRV4500804 RDFRV4500804ED

4 mm Passo alette / Fin spacing - 8 Numero ranghi / Rows number

		Tc	-5°C(*)	0°C(*)	2°C	4°C	6°C	8°C	10°C	12°C	15°C
ΔT 10	UR/RH 76% kW		62,10	67,70	69,42	71,14	72,86	74,58	76,30	78,60	82,05
ΔT 9	UR/RH 79% kW		57,60	62,80	64,38	65,96	67,54	69,12	70,70	72,80	75,95
ΔT 8	UR/RH 82% kW		52,80	57,50	58,96	60,42	61,88	63,34	64,80	66,70	69,55
ΔT 7	UR/RH 85% kW		47,60	51,80	53,10	54,40	55,70	57,00	58,30	60,20	63,05
ΔT 6	UR/RH 89% kW		42,30	46,20	47,46	48,72	49,98	51,24	52,50	54,40	57,25
ΔT 5	UR/RH 93% kW		36,70	40,30	41,52	42,74	43,96	45,18	46,40	48,20	50,90

Tc = temperatura cella / cold room temperature

(*) Per modelli passo alette 4mm, si consiglia un utilizzo ad una Tc ≥ +2°C - For 4 mm fin spacing models we recommend to use the application Tc ≥ +2°C

Refrigerating output

Motore S_ 6 poli bassa velocità / Motor S_ 6 poles low speed (590 Rpm)

RDFRS1500608 RDFRS1500608ED

8 mm Passo alette / Fin spacing - 6 Numero ranghi / Rows number

Tc			-35°C	-30°C	-25°C	-20°C	-15°C	-10°C	-5°C	0°C	2°C	4°C
ΔT 10	UR/RH 76%	kW	5,48	6,06	6,46	6,85	7,25	7,64	8,05	8,56	8,70	8,84
ΔT 9	UR/RH 79%	kW	5,13	5,62	5,96	6,29	6,63	6,96	7,35	7,83	7,97	8,11
ΔT 8	UR/RH 82%	kW	4,72	5,12	5,38	5,65	5,91	6,17	6,52	6,96	7,09	7,22
ΔT 7	UR/RH 85%	kW	4,28	4,60	4,82	5,03	5,25	5,46	5,78	6,20	6,32	6,44
ΔT 6	UR/RH 89%	kW	3,79	4,04	4,22	4,41	4,59	4,77	5,07	5,46	5,59	5,71
ΔT 5	UR/RH 93%	kW	3,26	3,44	3,59	3,75	3,90	4,05	4,33	4,71	4,84	4,97

Motore S_ 6 poli bassa velocità / Motor S_ 6 poles low speed (590 Rpm)

RDFRS1500808 RDFRS1500808ED

8 mm Passo alette / Fin spacing - 8 Numero ranghi / Rows number

Tc			-35°C	-30°C	-25°C	-20°C	-15°C	-10°C	-5°C	0°C	2°C	4°C
ΔT 10	UR/RH 76%	kW	6,32	6,91	7,32	7,73	8,13	8,54	8,99	9,55	9,70	9,85
ΔT 9	UR/RH 79%	kW	5,90	6,39	6,71	7,02	7,34	7,65	8,05	8,59	8,74	8,89
ΔT 8	UR/RH 82%	kW	5,42	5,82	6,09	6,35	6,62	6,88	7,26	7,76	7,91	8,05
ΔT 7	UR/RH 85%	kW	4,89	5,22	5,44	5,66	5,78	6,09	6,44	6,90	7,04	7,18
ΔT 6	UR/RH 89%	kW	4,32	4,57	4,76	4,94	5,13	5,31	5,65	6,09	6,24	6,38
ΔT 5	UR/RH 93%	kW	3,69	3,88	4,04	4,20	4,35	4,51	4,83	5,26	5,41	5,55

Motore S_ 6 poli bassa velocità / Motor S_ 6 poles low speed (590 Rpm)

RDFRS2500608 RDFRS2500608ED

8 mm Passo alette / Fin spacing - 6 Numero ranghi / Rows number

Tc			-35°C	-30°C	-25°C	-20°C	-15°C	-10°C	-5°C	0°C	2°C	4°C
ΔT 10	UR/RH 76%	kW	11,30	12,40	13,15	13,90	14,65	15,40	16,20	17,20	17,48	17,76
ΔT 9	UR/RH 79%	kW	10,50	11,50	12,13	12,75	13,38	14,00	14,80	15,70	15,98	16,26
ΔT 8	UR/RH 82%	kW	9,69	10,40	10,90	11,40	11,90	12,40	13,10	14,00	14,26	14,52
ΔT 7	UR/RH 85%	kW	8,75	9,36	9,77	10,18	10,59	11,00	11,60	12,40	12,66	12,92
ΔT 6	UR/RH 89%	kW	7,72	8,19	8,54	8,88	9,23	9,57	10,20	11,00	11,24	11,48
ΔT 5	UR/RH 93%	kW	6,62	6,96	7,25	7,54	7,83	8,12	8,69	9,45	9,70	9,95

Motore S_ 6 poli bassa velocità / Motor S_ 6 poles low speed (590 Rpm)

RDFRS2500808 RDFRS2500808ED

8 mm Passo alette / Fin spacing - 8 Numero ranghi / Rows number

Tc			-35°C	-30°C	-25°C	-20°C	-15°C	-10°C	-5°C	0°C	2°C	4°C
ΔT 10	UR/RH 76%	kW	13,00	14,10	14,88	15,65	16,43	17,20	18,10	19,20	19,50	19,80
ΔT 9	UR/RH 79%	kW	12,10	13,00	13,60	14,20	14,80	15,40	16,20	17,20	17,52	17,84
ΔT 8	UR/RH 82%	kW	11,10	11,90	12,38	12,85	13,33	13,80	14,60	15,60	15,88	16,16
ΔT 7	UR/RH 85%	kW	9,99	10,60	11,00	11,40	11,80	12,20	12,90	13,90	14,16	14,42
ΔT 6	UR/RH 89%	kW	8,79	9,26	9,62	9,98	10,34	10,70	11,30	12,20	12,50	12,80
ΔT 5	UR/RH 93%	kW	7,51	7,83	8,14	8,44	8,75	9,05	9,68	10,50	10,80	11,10

Tc = temperatura cella / cold room temperature

Motore S_ 6 poli bassa velocità / Motor S_ 6 poles low speed (590 Rpm)
RDFRS3500608 RDFRS3500608ED

8 mm Passo alette / Fin spacing - 6 Numero ranghi / Rows number

Tc			-35°C	-30°C	-25°C	-20°C	-15°C	-10°C	-5°C	0°C	2°C	4°C
ΔT 10	UR/RH 76%	kW	17,10	18,70	19,83	20,95	22,08	23,20	24,30	25,80	26,22	26,64
ΔT 9	UR/RH 79%	kW	16,00	17,30	18,25	19,20	20,15	21,10	22,20	23,60	24,00	24,40
ΔT 8	UR/RH 82%	kW	14,70	15,80	16,53	17,25	17,98	18,70	19,70	21,00	21,38	21,76
ΔT 7	UR/RH 85%	kW	13,20	14,10	14,70	15,30	15,90	16,50	17,40	18,70	19,06	19,42
ΔT 6	UR/RH 89%	kW	11,70	12,40	12,90	13,40	13,90	14,40	15,30	16,50	16,86	17,22
ΔT 5	UR/RH 93%	kW	9,97	10,50	10,93	11,35	11,78	12,20	13,00	14,20	14,58	14,96

Motore S_ 6 poli bassa velocità / Motor S_ 6 poles low speed (590 Rpm)
RDFRS3500808 RDFRS3500808ED

8 mm Passo alette / Fin spacing - 8 Numero ranghi / Rows number

Tc			-35°C	-30°C	-25°C	-20°C	-15°C	-10°C	-5°C	0°C	2°C	4°C
ΔT 10	UR/RH 76%	kW	20,30	21,90	23,00	24,10	25,20	26,30	27,60	29,30	29,80	30,30
ΔT 9	UR/RH 79%	kW	18,80	20,20	21,03	21,85	22,68	23,50	24,70	26,30	26,78	27,26
ΔT 8	UR/RH 82%	kW	17,20	18,30	19,00	19,70	20,40	21,10	22,30	23,80	24,26	24,72
ΔT 7	UR/RH 85%	kW	15,50	16,30	16,90	17,50	18,10	18,70	19,70	21,20	21,62	22,04
ΔT 6	UR/RH 89%	kW	13,60	14,20	14,73	15,25	15,78	16,30	17,30	18,70	19,14	19,58
ΔT 5	UR/RH 93%	kW	11,60	12,10	12,53	12,95	13,38	13,80	14,80	16,10	16,56	17,02

Motore S_ 6 poli bassa velocità / Motor S_ 6 poles low speed (590 Rpm)
RDFRS4500608 RDFRS4500608ED

8 mm Passo alette / Fin spacing - 6 Numero ranghi / Rows number

Tc			-35°C	-30°C	-25°C	-20°C	-15°C	-10°C	-5°C	0°C	2°C	4°C
ΔT 10	UR/RH 76%	kW	18,40	21,00	23,03	25,05	27,08	29,10	31,00	33,10	33,72	34,34
ΔT 9	UR/RH 79%	kW	17,40	19,70	21,43	23,15	24,88	26,60	28,40	30,40	31,00	31,60
ΔT 8	UR/RH 82%	kW	16,30	18,30	19,68	21,05	22,43	23,80	25,30	27,20	27,76	28,32
ΔT 7	UR/RH 85%	kW	14,90	16,60	17,73	18,85	19,98	21,10	22,50	24,30	24,82	25,34
ΔT 6	UR/RH 89%	kW	13,40	14,80	15,73	16,65	17,58	18,50	19,80	21,50	22,02	22,54
ΔT 5	UR/RH 93%	kW	11,70	12,70	13,48	14,25	15,03	15,80	17,00	18,60	19,12	19,64

Motore S_ 6 poli bassa velocità / Motor S_ 6 poles low speed (590 Rpm)
RDFRS4500808 RDFRS4500808ED

8 mm Passo alette / Fin spacing - 8 Numero ranghi / Rows number

Tc			-35°C	-30°C	-25°C	-20°C	-15°C	-10°C	-5°C	0°C	2°C	4°C
ΔT 10	UR/RH 76%	kW	22,40	25,10	27,05	29,00	30,95	32,90	34,80	37,90	38,62	39,34
ΔT 9	UR/RH 79%	kW	21,00	23,50	25,15	26,80	28,45	30,10	31,90	34,20	34,88	35,56
ΔT 8	UR/RH 82%	kW	19,50	21,60	22,98	24,35	25,73	27,10	28,90	31,00	31,64	32,28
ΔT 7	UR/RH 85%	kW	17,90	19,50	20,65	21,80	22,95	24,10	25,70	27,70	28,30	28,90
ΔT 6	UR/RH 89%	kW	16,00	17,30	18,25	19,20	20,15	21,10	22,60	24,50	25,10	25,70
ΔT 5	UR/RH 93%	kW	13,90	14,90	15,68	16,45	17,23	18,00	19,40	21,20	21,82	22,44

Tc = temperatura cella / cold room temperature

Refrigerating output

Motore S_ 6 poli alta velocità / Motor S_ 6 poles high speed (870 Rpm)

RDFRS1500608 RDFRS1500608ED

8 mm Passo alette / Fin spacing - 6 Numero ranghi / Rows number

Tc			-35°C	-30°C	-25°C	-20°C	-15°C	-10°C	-5°C	0°C	2°C	4°C
ΔT 10	UR/RH 76%	kW	6,35	7,20	7,80	8,40	8,99	9,59	10,10	10,80	10,96	11,12
ΔT 9	UR/RH 79%	kW	5,98	6,70	7,22	7,74	8,25	8,77	9,28	9,88	10,04	10,21
ΔT 8	UR/RH 82%	kW	5,56	6,18	6,61	7,05	7,48	7,91	8,37	8,94	9,09	9,25
ΔT 7	UR/RH 85%	kW	5,08	5,56	5,93	6,29	6,66	7,02	7,43	7,96	8,10	8,25
ΔT 6	UR/RH 89%	kW	4,53	4,93	5,23	5,53	5,83	6,13	6,52	7,02	7,17	7,32
ΔT 5	UR/RH 93%	kW	3,93	4,23	4,48	4,73	4,97	5,22	5,58	6,05	6,20	6,35

Motore S_ 6 poli alta velocità / Motor S_ 6 poles high speed (870 Rpm)

RDFRS2500608 RDFRS2500608ED

8 mm Passo alette / Fin spacing - 6 Numero ranghi / Rows number

Tc			-35°C	-30°C	-25°C	-20°C	-15°C	-10°C	-5°C	0°C	2°C	4°C
ΔT 10	UR/RH 76%	kW	13,20	14,80	15,95	17,10	18,25	19,40	20,50	21,70	22,04	22,38
ΔT 9	UR/RH 79%	kW	12,40	13,80	14,78	15,75	16,73	17,70	18,70	19,90	20,22	20,54
ΔT 8	UR/RH 82%	kW	11,50	12,70	13,53	14,35	15,18	16,00	16,90	18,00	18,30	18,60
ΔT 7	UR/RH 85%	kW	10,40	11,40	12,08	12,75	13,43	14,10	15,00	16,00	16,28	16,56
ΔT 6	UR/RH 89%	kW	9,28	10,00	10,58	11,15	11,73	12,30	13,10	14,10	14,40	14,70
ΔT 5	UR/RH 93%	kW	8,03	8,58	9,06	9,54	10,02	10,50	11,20	12,10	12,40	12,70

Motore S_ 6 poli alta velocità / Motor S_ 6 poles high speed (870 Rpm)

RDFRS3500608 RDFRS3500608ED

8 mm Passo alette / Fin spacing - 6 Numero ranghi / Rows number

Tc			-35°C	-30°C	-25°C	-20°C	-15°C	-10°C	-5°C	0°C	2°C	4°C
ΔT 10	UR/RH 76%	kW	20,10	22,50	24,18	25,85	27,53	29,20	30,80	32,70	33,18	33,66
ΔT 9	UR/RH 79%	kW	18,80	20,90	22,33	23,75	25,18	26,60	28,10	29,90	30,38	30,86
ΔT 8	UR/RH 82%	kW	17,40	19,20	20,40	21,60	22,80	24,00	25,30	27,00	27,46	27,92
ΔT 7	UR/RH 85%	kW	15,80	17,20	18,23	19,25	20,28	21,30	22,50	24,00	24,44	24,88
ΔT 6	UR/RH 89%	kW	14,10	15,20	16,05	16,90	17,75	18,60	19,70	21,20	21,64	22,08
ΔT 5	UR/RH 93%	kW	12,10	13,00	13,70	14,40	15,10	15,80	16,80	18,20	18,66	19,12

Motore S_ 6 poli alta velocità / Motor S_ 6 poles high speed (870 Rpm)

RDFRS4500608 RDFRS4500608ED

8 mm Passo alette / Fin spacing - 6 Numero ranghi / Rows number

Tc			-35°C	-30°C	-25°C	-20°C	-15°C	-10°C	-5°C	0°C	2°C	4°C
ΔT 10	UR/RH 76%	kW	20,60	24,10	27,00	29,90	32,80	35,70	38,30	41,20	41,98	42,76
ΔT 9	UR/RH 79%	kW	19,60	22,80	25,33	27,85	30,38	32,90	35,30	37,90	38,66	39,42
ΔT 8	UR/RH 82%	kW	18,40	21,20	23,38	25,55	27,73	29,90	32,00	34,40	35,10	35,80
ΔT 7	UR/RH 85%	kW	17,10	19,40	21,23	23,05	24,88	26,70	28,60	30,80	31,44	32,08
ΔT 6	UR/RH 89%	kW	15,50	17,50	19,00	20,50	22,00	23,50	25,20	27,30	27,94	28,58
ΔT 5	UR/RH 93%	kW	13,70	15,20	16,45	17,70	18,95	20,20	21,70	23,60	24,24	24,88

Tc = temperatura cella / cold room temperature

Motore V_ 4 poli bassa velocità / Motor V_ 4 poles low speed (1025 Rpm)

RDFRV1500608 RDFRV1500608ED			8 mm Passo alette / Fin spacing - 6 Numero ranghi / Rows number									
Tc			-35°C	-30°C	-25°C	-20°C	-15°C	-10°C	-5°C	0°C	2°C	4°C
ΔT 10	UR/RH 76%	kW	6,72	7,71	8,43	9,16	9,88	10,60	11,20	12,00	12,20	12,40
ΔT 9	UR/RH 79%	kW	6,37	7,23	7,85	8,47	9,08	9,70	10,30	11,00	11,18	11,36
ΔT 8	UR/RH 82%	kW	5,95	6,69	7,21	7,73	8,25	8,77	9,29	9,91	10,09	10,27
ΔT 7	UR/RH 85%	kW	5,46	6,09	6,52	6,94	7,37	7,79	8,26	8,82	8,98	9,14
ΔT 6	UR/RH 89%	kW	4,91	5,41	5,76	6,11	6,46	6,81	7,25	7,78	7,94	8,10
ΔT 5	UR/RH 93%	kW	4,28	4,66	4,95	5,23	5,52	5,80	6,19	6,71	6,87	7,04

Motore V_ 4 poli bassa velocità / Motor V_ 4 poles low speed (1025 Rpm)

RDFRV2500608 RDFRV2500608ED			8 mm Passo alette / Fin spacing - 6 Numero ranghi / Rows number									
Tc			-35°C	-30°C	-25°C	-20°C	-15°C	-10°C	-5°C	0°C	2°C	4°C
ΔT 10	UR/RH 76%	kW	14,00	15,90	17,28	18,65	20,03	21,40	22,70	24,40	24,76	25,12
ΔT 9	UR/RH 79%	kW	13,20	14,90	16,08	17,25	18,43	19,60	20,80	22,10	22,44	22,78
ΔT 8	UR/RH 82%	kW	12,30	13,80	14,78	15,75	16,73	17,70	18,70	19,90	20,24	20,58
ΔT 7	UR/RH 85%	kW	11,30	12,50	13,30	14,10	14,90	15,70	16,60	17,70	18,02	18,34
ΔT 6	UR/RH 89%	kW	10,10	11,10	11,75	12,40	13,05	13,70	14,60	15,60	15,92	16,24
ΔT 5	UR/RH 93%	kW	8,80	9,51	10,06	10,61	11,15	11,70	12,40	13,50	13,82	14,14

Motore V_ 4 poli bassa velocità / Motor V_ 4 poles low speed (1025 Rpm)

RDFRV3500608 RDFRV3500608ED			8 mm Passo alette / Fin spacing - 6 Numero ranghi / Rows number									
Tc			-35°C	-30°C	-25°C	-20°C	-15°C	-10°C	-5°C	0°C	2°C	4°C
ΔT 10	UR/RH 76%	kW	21,30	24,20	26,23	28,25	30,28	32,30	34,60	36,70	37,24	37,78
ΔT 9	UR/RH 79%	kW	20,10	22,60	24,33	26,05	27,78	29,50	31,20	33,20	33,72	34,24
ΔT 8	UR/RH 82%	kW	18,70	20,90	22,33	23,75	25,18	26,60	28,20	30,00	30,50	31,00
ΔT 7	UR/RH 85%	kW	17,10	18,90	20,08	21,25	22,43	23,60	25,00	26,70	27,16	27,62
ΔT 6	UR/RH 89%	kW	15,30	16,70	17,68	18,65	19,63	20,60	21,90	23,50	23,98	24,46
ΔT 5	UR/RH 93%	kW	13,30	14,40	15,18	15,95	16,73	17,50	18,70	20,20	20,70	21,20

Motore V_ 4 poli bassa velocità / Motor V_ 4 poles low speed (1025 Rpm)

RDFRV4500608 RDFRV4500608ED			8 mm Passo alette / Fin spacing - 6 Numero ranghi / Rows number									
Tc			-35°C	-30°C	-25°C	-20°C	-15°C	-10°C	-5°C	0°C	2°C	4°C
ΔT 10	UR/RH 76%	kW	21,50	25,50	28,88	32,25	35,63	39,00	42,00	45,30	46,18	47,06
ΔT 9	UR/RH 79%	kW	20,60	24,20	27,15	30,10	33,05	36,00	38,70	41,70	42,54	43,38
ΔT 8	UR/RH 82%	kW	19,40	22,70	25,23	27,75	30,28	32,80	35,20	37,90	38,68	39,46
ΔT 7	UR/RH 85%	kW	18,10	20,90	23,03	25,15	27,28	29,40	31,50	33,90	34,62	35,34
ΔT 6	UR/RH 89%	kW	16,50	18,90	20,65	22,40	24,15	25,90	27,80	30,10	30,80	31,50
ΔT 5	UR/RH 93%	kW	14,70	16,60	18,00	19,40	20,80	22,20	24,00	26,10	26,80	27,50

Tc = temperatura cella / cold room temperature

Refrigerating output

Motore V_ 4 poli alta velocità / Motor V_ 4 poles high speed (1300 Rpm)

RDFRV1500608 RDFRV1500608ED

8 mm Passo alette / Fin spacing - 6 Numero ranghi / Rows number

Tc			-35°C	-30°C	-25°C	-20°C	-15°C	-10°C	-5°C	0°C	2°C	4°C
ΔT 10	UR/RH 76%	kW	7,15	8,31	9,23	10,16	11,08	12,00	12,80	13,70	13,90	14,10
ΔT 9	UR/RH 79%	kW	6,79	7,83	8,62	9,42	10,21	11,00	11,70	12,50	12,70	12,90
ΔT 8	UR/RH 82%	kW	6,38	7,28	7,96	8,64	9,32	10,00	10,60	11,30	11,50	11,70
ΔT 7	UR/RH 85%	kW	5,89	6,66	7,22	7,79	8,35	8,91	9,46	10,10	10,28	10,46
ΔT 6	UR/RH 89%	kW	5,34	5,96	6,41	6,87	7,32	7,77	8,27	8,88	9,06	9,24
ΔT 5	UR/RH 93%	kW	4,69	5,16	5,53	5,89	6,26	6,62	7,08	7,65	7,83	8,01

Motore V_ 4 poli alta velocità / Motor V_ 4 poles high speed (1300 Rpm)

RDFRV1500808 RDFRV1500808ED

8 mm Passo alette / Fin spacing - 8 Numero ranghi / Rows number

Tc			-35°C	-30°C	-25°C	-20°C	-15°C	-10°C	-5°C	0°C	2°C	4°C
ΔT 10	UR/RH 76%	kW	8,59	9,93	10,95	11,97	12,98	14,00	14,90	15,90	16,14	16,38
ΔT 9	UR/RH 79%	kW	8,15	9,36	10,22	11,08	11,94	12,80	13,60	14,50	14,76	15,02
ΔT 8	UR/RH 82%	kW	7,64	8,61	9,36	10,11	10,85	11,60	12,30	13,20	13,42	13,64
ΔT 7	UR/RH 85%	kW	6,99	7,86	8,50	9,13	9,77	10,40	11,00	11,70	11,92	12,14
ΔT 6	UR/RH 89%	kW	6,31	7,00	7,52	8,03	8,55	9,06	9,64	10,40	10,60	10,80
ΔT 5	UR/RH 93%	kW	5,54	6,07	6,49	6,90	7,32	7,73	8,26	8,93	9,14	9,36

Motore V_ 4 poli alta velocità / Motor V_ 4 poles high speed (1300 Rpm)

RDFRV2500608 RDFRV2500608ED

8 mm Passo alette / Fin spacing - 6 Numero ranghi / Rows number

Tc			-35°C	-30°C	-25°C	-20°C	-15°C	-10°C	-5°C	0°C	2°C	4°C
ΔT 10	UR/RH 76%	kW	15,00	17,30	19,08	20,85	22,63	24,40	25,90	27,60	28,00	28,40
ΔT 9	UR/RH 79%	kW	14,20	16,20	17,75	19,30	20,85	22,40	23,80	25,30	25,70	26,10
ΔT 8	UR/RH 82%	kW	13,30	15,00	16,33	17,65	18,98	20,30	21,50	22,90	23,26	23,62
ΔT 7	UR/RH 85%	kW	12,20	13,70	14,78	15,85	16,93	18,00	19,10	20,40	20,74	21,08
ΔT 6	UR/RH 89%	kW	11,00	12,20	13,08	13,95	14,83	15,70	16,70	17,90	18,24	18,58
ΔT 5	UR/RH 93%	kW	9,64	10,60	11,30	12,00	12,70	13,40	14,30	15,40	15,76	16,12

Motore V_ 4 poli alta velocità / Motor V_ 4 poles high speed (1300 Rpm)

RDFRV2500808 RDFRV2500808ED

8 mm Passo alette / Fin spacing - 8 Numero ranghi / Rows number

Tc			-35°C	-30°C	-25°C	-20°C	-15°C	-10°C	-5°C	0°C	2°C	4°C
ΔT 10	UR/RH 76%	kW	18,00	20,60	22,55	24,50	26,45	28,40	30,10	32,00	32,48	32,96
ΔT 9	UR/RH 79%	kW	17,00	19,30	20,98	22,65	24,33	26,00	27,60	29,30	29,78	30,26
ΔT 8	UR/RH 82%	kW	15,90	17,90	19,30	20,70	22,10	23,50	24,90	26,50	26,94	27,38
ΔT 7	UR/RH 85%	kW	14,50	16,20	17,38	18,55	19,73	20,90	22,20	23,60	24,02	24,44
ΔT 6	UR/RH 89%	kW	13,00	14,40	15,38	16,35	17,33	18,30	19,40	20,90	21,30	21,70
ΔT 5	UR/RH 93%	kW	11,40	12,40	13,20	14,00	14,80	15,60	16,60	18,00	18,42	18,84

Tc = temperatura cella / cold room temperature

Motore V_ 4 poli alta velocità / Motor V_ 4 poles high speed (1300 Rpm)
RDFRV3500608 RDFRV3500608ED

8 mm Passo alette / Fin spacing - 6 Numero ranghi / Rows number

		Tc	-35°C	-30°C	-25°C	-20°C	-15°C	-10°C	-5°C	0°C	2°C	4°C
ΔT 10	UR/RH 76% kW		22,80	26,20	28,85	31,50	34,15	36,80	39,10	41,50	42,10	42,70
ΔT 9	UR/RH 79% kW		21,60	24,60	26,90	29,20	31,50	33,80	35,80	38,00	38,60	39,20
ΔT 8	UR/RH 82% kW		20,20	22,80	24,73	26,65	28,58	30,50	32,30	34,40	34,94	35,48
ΔT 7	UR/RH 85% kW		18,60	20,80	22,38	23,95	25,53	27,10	28,70	30,60	31,12	31,64
ΔT 6	UR/RH 89% kW		16,70	18,50	19,78	21,05	22,33	23,60	25,10	26,80	27,34	27,88
ΔT 5	UR/RH 93% kW		14,60	16,00	17,03	18,05	19,08	20,10	21,40	23,10	23,64	24,18

Motore V_ 4 poli alta velocità / Motor V_ 4 poles high speed (1300 Rpm)
RDFRV3500808 RDFRV3500808ED

8 mm Passo alette / Fin spacing - 8 Numero ranghi / Rows number

		Tc	-35°C	-30°C	-25°C	-20°C	-15°C	-10°C	-5°C	0°C	2°C	4°C
ΔT 10	UR/RH 76% kW		28,60	32,60	35,50	38,40	41,30	44,20	46,70	49,70	50,44	51,18
ΔT 9	UR/RH 79% kW		27,00	30,50	32,98	35,45	37,93	40,40	42,70	45,50	46,24	46,98
ΔT 8	UR/RH 82% kW		25,20	28,20	30,28	32,35	34,43	36,50	38,60	41,20	41,88	42,56
ΔT 7	UR/RH 85% kW		22,90	25,40	27,15	28,90	30,65	32,40	34,30	36,60	37,24	37,88
ΔT 6	UR/RH 89% kW		20,60	22,50	23,95	25,40	26,85	28,30	30,10	32,30	32,96	33,62
ΔT 5	UR/RH 93% kW		17,90	19,40	20,58	21,75	22,93	24,10	25,70	27,80	28,48	29,16

Motore V_ 4 poli alta velocità / Motor V_ 4 poles high speed (1300 Rpm)
RDFRV4500608 RDFRV4500608ED

8 mm Passo alette / Fin spacing - 6 Numero ranghi / Rows number

		Tc	-35°C	-30°C	-25°C	-20°C	-15°C	-10°C	-5°C	0°C	2°C	4°C
ΔT 10	UR/RH 76% kW		22,50	26,90	31,05	35,20	39,35	43,50	47,20	51,00	52,06	53,12
ΔT 9	UR/RH 79% kW		21,50	25,70	29,38	33,05	36,73	40,40	43,60	47,10	48,08	49,06
ΔT 8	UR/RH 82% kW		20,50	24,20	27,38	30,55	33,73	36,90	39,80	43,00	43,88	44,76
ΔT 7	UR/RH 85% kW		19,20	22,40	25,10	27,80	30,50	33,20	35,70	38,50	39,32	40,14
ΔT 6	UR/RH 89% kW		17,60	20,40	22,63	24,85	27,08	29,30	31,50	34,10	34,90	35,70
ΔT 5	UR/RH 93% kW		15,70	18,00	19,78	21,55	23,33	25,10	27,10	29,60	30,36	31,12

Motore V_ 4 poli alta velocità / Motor V_ 4 poles high speed (1300 Rpm)
RDFRV4500808 RDFRV4500808ED

8 mm Passo alette / Fin spacing - 8 Numero ranghi / Rows number

		Tc	-35°C	-30°C	-25°C	-20°C	-15°C	-10°C	-5°C	0°C	2°C	4°C
ΔT 10	UR/RH 76% kW		28,60	34,00	38,73	43,45	48,18	52,90	57,20	61,70	62,96	64,22
ΔT 9	UR/RH 79% kW		27,40	32,30	36,48	40,65	44,83	49,00	52,80	56,90	58,08	59,26
ΔT 8	UR/RH 82% kW		25,08	30,20	33,83	37,45	41,08	44,70	48,00	51,80	52,88	53,96
ΔT 7	UR/RH 85% kW		24,10	27,90	30,95	34,00	37,05	40,10	43,00	46,40	47,40	48,40
ΔT 6	UR/RH 89% kW		22,00	25,20	27,75	30,30	32,85	35,40	38,00	41,20	42,18	43,16
ΔT 5	UR/RH 93% kW		19,60	22,20	24,25	26,30	28,35	30,40	32,80	35,70	36,66	37,62

Tc = temperatura cella / cold room temperature

LETTURA CODICE / MODEL DESIGNATION

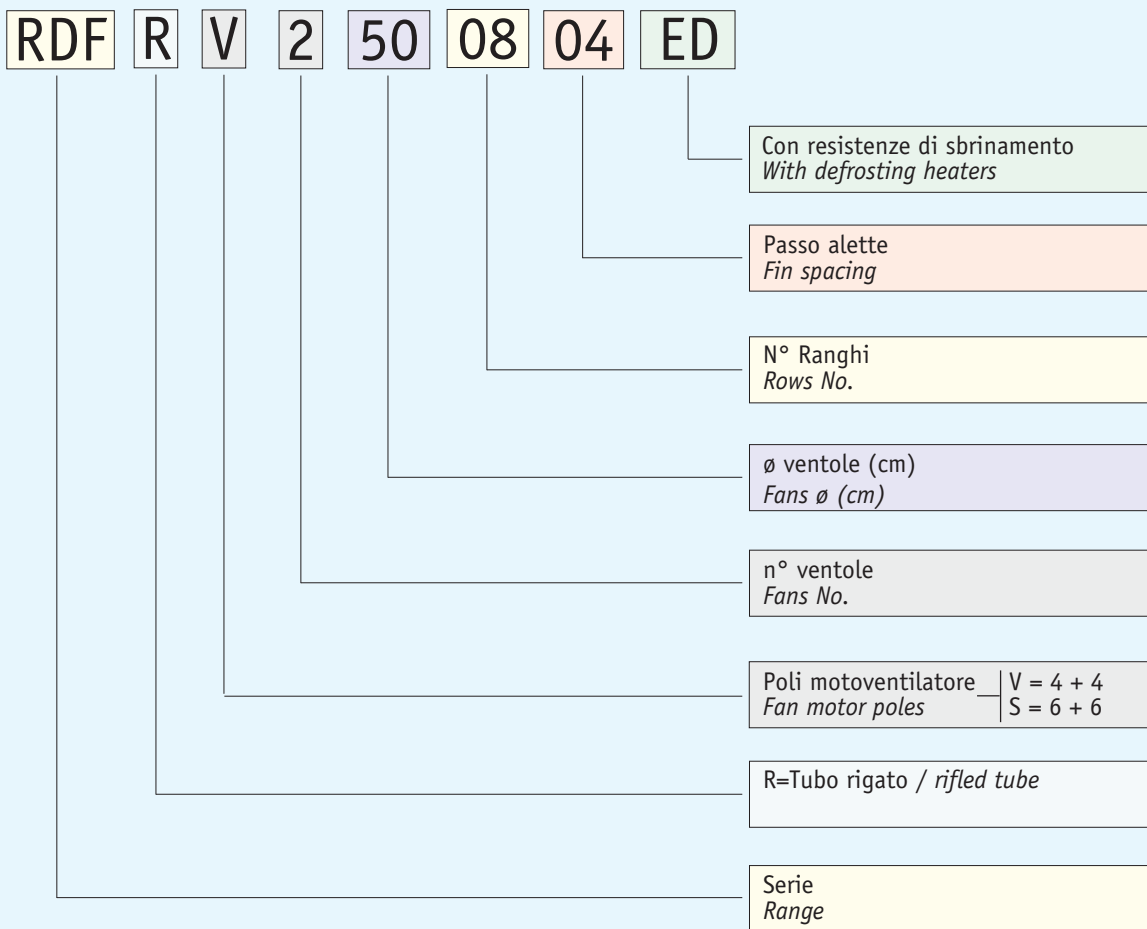



Per ulteriori informazioni, contattare il nostro ufficio tecnico / For further information, please contact our technical dept

Descrizione, dati tecnici e illustrazioni sono indicativi e non vincolanti. La Rivacold si riserva il diritto di modificare per intero o in parte le specifiche descritte nella presente documentazione senza preavviso e a beneficio della continuità produttiva, di utilizzare produttori alternativi di componenti previsti nel progetto

Descriptions, technical data and pictures are to be considered as a guide and not binding. Rivacold reserves the right to change in whole or part, the specification detailed in this documentation without prior notice and, when necessary to achieve continuous production, to use alternative manufactures of components for the design accomplishment

Aeroevaporatori Rivacold

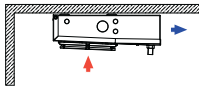
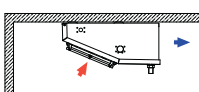
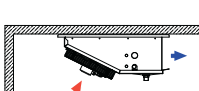
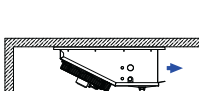
Rivacold unit coolers

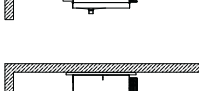
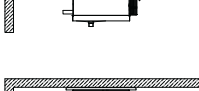
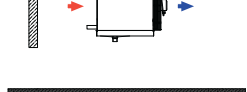
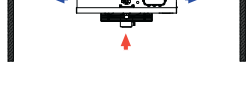
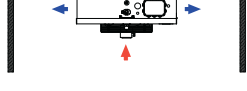
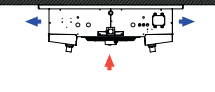
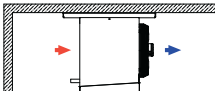
Serie Range	Potenza / Capacity								Ventole Fans	
	1000W	2000W	4000W	8000W	16000W	32000W	64000W	128000W		
RS	109 - 2640 w									1 - 4
RSV	350 - 2930 w									1 - 2
RSI 250	440 - 5380 w									1 - 4
RSI 350	1580 - 11600 w									2 - 4
RC	602 - 7380 w									1 - 4
RCS	410 - 8120 w									1 - 4
RCMR	1840 - 22400 w									1 - 4
RDF 250	400 - 5710 w									1 - 4
RDF 350	1630 - 17400 w									2 - 5
RDFR 500	3260 - 82050 w									1 - 4
RCBR 500	2950 - 59800 w									1 - 4
RCBR 630	3180 - 71200 w									1 - 4

RIVACOLD s.r.l.

Costruzione Gruppi Frigoriferi e Accessori

Via Sicilia, 7 - 61020 Montecchio PU - Italy

Tel. +39.0721.919911 - Fax +39.0721.490015

www.rivacold.com / info@rivacold.com



A Member of **RIVACOLD GROUP** 