

AEROEVAPORATORI A SOFFITTO
doppio flusso
Ceiling unit coolers
dual air flow



RIVACOLD

Tabella / Table

(A)	RDF1250 RDF1250ED
(B)	RDF2250 RDF2250ED
(C)	RDF3250 RDF3250ED
(D)	RDF4250 RDF4250ED



(A)



(B)



(C)



(D)

Tabella / Table

(A)	RDF23503 RDF23503ED RDF23507 RDF23507ED
(B)	RDF33503 RDF33503ED RDF33507 RDF33507ED
(C)	RDF43503 RDF43503ED RDF43507 RDF43507ED
(D)	RDF53503 RDF53503ED RDF53507 RDF53507ED

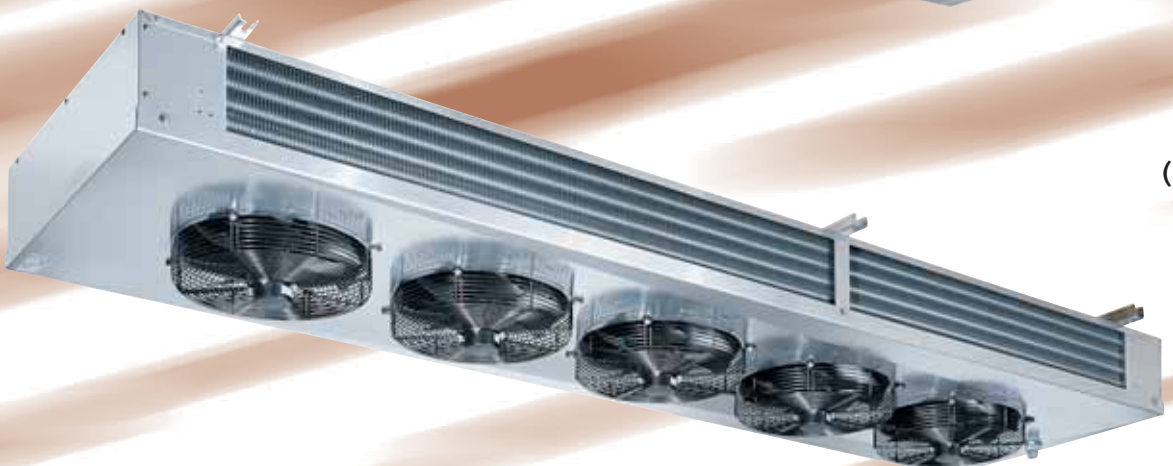

Aeroevaporatori a soffitto RDF

doppio flusso

RDF Ceiling unit coolers

dual air flow

Caratteristiche generali

Gli aeroevaporatori della serie RDF sono stati ideati per essere installati in celle frigorifere per la conservazione di prodotti freschi e congelati. La caratteristica principale di questa gamma è quella di gettare aria da entrambi i lati; questo consente il posizionamento dell'evaporatore al centro della cella favorendo un ricircolo dell'aria uniforme a vantaggio di un'ottima conservazione del prodotto. La gamma RDF è disponibile con due differenti diametri di ventola e tre diversi passi alette a seconda dell'applicazione richiesta. Inoltre i modelli aventi diametro da 250 mm sono realizzati con geometria 25 x 21,65 e tubo da 3/8", mentre quelli con diametro da 350 mm hanno una geometria 37,5 x 32,5 e tubo da 12 mm. I modelli con ventola di diametro da 350 mm sono dotati di un motoventilatore a due velocità utilizzabili a seconda dell'applicazione richiesta. La serie ED, fornita di resistenze di sbrinamento già montate, è adatta per essere utilizzata alle basse temperature.

General features

RDF range unit coolers have been designed to be installed inside cold rooms suited for fresh and frozen goods storage. The main feature of this range is of throwing air from both sides; this allows the unit cooler to be placed in the middle of the cold room ceiling giving a uniform air flow and, as a result, the best product conservation.

RDF range is available in two different fan diameters and three types of fin spacing according to the needed application. Furthermore, the models having 250 mm fan diameter are made with a geometry of 25 x 21,65 and 3/8" tube, whereas those having 350 mm fan diameter are made with a geometry of 37,5 x 32,5 and 12 mm tube size.

Models having 350 mm fan diameters are equipped with fan motors of double speed giving the opportunity of using the proper version according to the application needed. The ED version is supplied with mounted defrosting heaters and is suitable for being used at low temperature applications.

Optional - Optional items

- Batteria verniciata
Varnished coil
- Resistenza per il tubo di scarico con alimentazione elettrica 220V/1/50Hz (per alimentazioni differenti contattare il nostro ufficio tecnico)
Drainage pipe heater of 220V/1/50Hz voltage (for different voltages please contact our technical dept)



Mod. RDF.250...: lato collegamento frigorifero ed elettrico.

RDF.250...: model; pipe and electrical connection side.



Mod. RDF.350...: lato collegamento frigorifero ed elettrico.

RDF.350...: model; pipe and electrical connection side.



Manufacturing features

Batteria

La gamma è costituita da due tipi di batterie costruite con alette in alluminio e tubo in rame: tubo da 3/8" con geometria 25 x 21,65, per i modelli con ventole di diametro da 250 mm; tubo da 12 mm con una geometria 37,5 x 32,5 per i modelli con ventole da 350 mm.

I modelli con diametro ventole 250 mm hanno una batteria con passo alette 4,5mm/9mm adatto per applicazioni di temperatura cella (Tc) da -30° C a +10°C.

I modelli con diametro ventole 350 mm si suddividono a loro volta in due gruppi : modelli con passo alette da 3,5 mm adatti per applicazioni di temperatura cella (Tc) da -5°C a +12°C; modelli con passo alette 7 mm adatti per applicazioni di temperatura cella (Tc) da -35°C a +4°C.

Le batterie vengono collaudate con azoto ad una pressione di 25bar

Motoventilatori

I motoventilatori utilizzati hanno le seguenti caratteristiche:

- costruiti nel rispetto delle norme EN 60335-1, con protezione termica interna
- diametro ventola 250 mm:
 - alimentazione 230-240V/1/50-60Hz
 - grado di protezione IP42
 - classe di isolamento B
 - temperatura di funzionamento da -40°C a + 40°C
- diametro ventola 350 mm:
 - alimentazione 230/1/50Hz
 - doppia velocità (1070-1360 Rpm)
 - grado di protezione IP44
 - classe di isolamento B
 - temperatura di funzionamento da -40°C a +45°C
- esecuzione elettrica conforme alla direttiva 2006/95/CE Bassa tensione

Carenatura

E' realizzata in alluminio. Le soluzioni costruttive adottate conferiscono robustezza alla carenatura e garantiscono l'assenza di vibrazioni durante il funzionamento. Le viti, le rondelle e i dadi sono di acciaio inossidabile.

Coil

The range consists of two types of coils , both made of aluminium fins and copper tube: 3/8" tube size with a geometry of 25 x 21,65, for models with 250 mm fan diameter; 12 mm tube size with a geometry of 37,5 x 32,5, for models with 350 mm fan diameter.

The model types having 250 mm fan diameter are fitted with a coil of 4,5 mm / 9 mm fin spacing, suited for applications with a cold room temperature (Tc) from -30°C to +10°C.

The model types having 350 mm fan diameter are made of two different groups: models with 3,5 mm fin spacing suited for cold room temperature (Tc) from -5°C to +12°C; models with 7 mm fin spacing suited for cold room temperature (Tc) from -35°C to +4°C.

The coils are tested with nitrogen at a pressure of 25 bar.

Fan motors

The fan motor models in use have the following features:

- manufactured following EN 60335-1 laws, with internal thermal protection
- fan diameter 250 mm:
 - power supply 230-240V/1/50-60HZ
 - IP42 protection rate
 - B insulation class
 - operating temperature from -40°C to + 40°C
- fan diameter 350mm:
 - power supply 230V/1/50Hz
 - double speed (1070-1360 Rpm)
 - IP44 protection rate
 - B insulation class
 - operating temperature from -40°C to + 45°C
- electric made in conformity with 2006/95/CE Low voltage directive

Housing

The housing is made of aluminium. The manufacturing solutions used give the housing strength and guarantee the absence of vibrations during the functioning. Screws, washers and nuts are made of stainless steel.



Manufacturing features

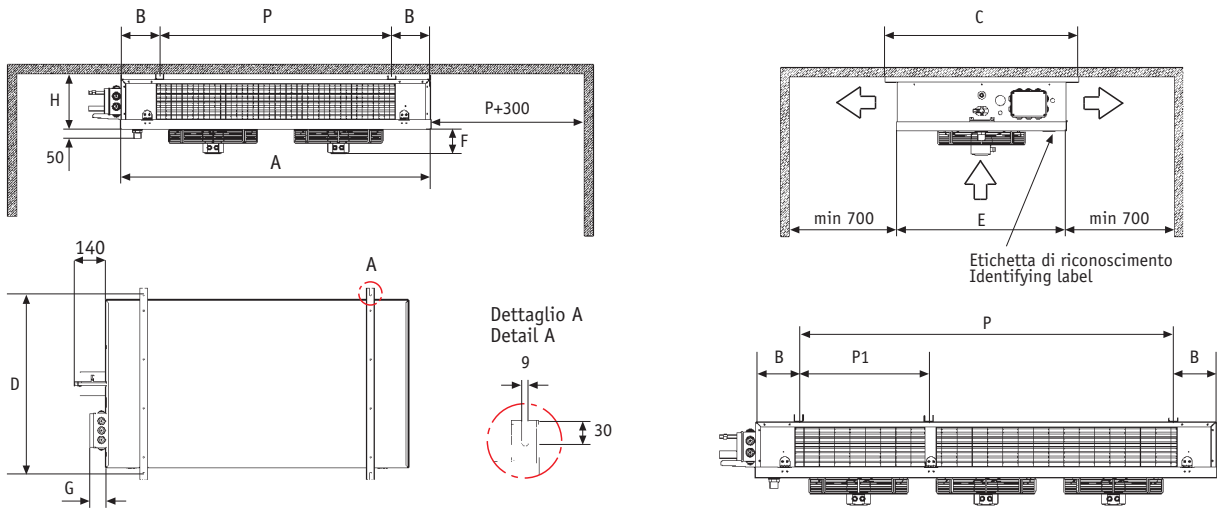

Serie RDF / RDF Range

Modello Model	RDF	1250-1250ED	2250-2250ED	3250-3250ED	4250-4250ED
Dimensioni Dimensions (mm)	A	522	922	1322	1722
	B	93,5	93,5	93,5	93,5
	C	710	710	710	710
	D	650	650	650	650
	E	638	638	638	638
	F	50	50	50	50
	G	60	60	60	60
	P	335	735	1135	1535
Attacchi Connections	ø ingresso - ø inlet	10 x 1mm - 1/2" SAE	10 x 1mm - 1/2" SAE	12 x 1mm - 1/2" SAE	12 x 1mm - 1/2" SAE
	ø uscita - ø outlet	12 x 1mm	12 x 1mm	18 x 1mm	22 x 1mm
	ø scarico - ø drain	1/2" gas (20mm)	1/2" gas (20mm)	1" gas (33mm)	1" gas (33mm)

Serie RDF / RDF Range

Modello Model	RDF	23503-23503ED 23507-23507ED	33503-33503ED 33507-33507ED	43503-43503ED 43507-43507ED	53503-53503ED 53507-53507ED
Dimensioni Dimensions (mm)	A	1366	1816	2266	2716
	B	173	173	173	173
	C	860	860	860	860
	D	800	800	800	800
	E	756	756	756	756
	F	110	110	110	110
	G	70	70	70	70
	H	241	246	251	256
	P	1020	1470	1920	2370
P1	---	510	960	960	
Attacchi Connections	ø ingresso - ø inlet	12 x 1mm - 1/2"SAE	12 x 1mm - 1/2"SAE	16 x 1mm - 5/8"SAE	16 x 1mm - 5/8"SAE
	ø uscita - ø outlet	22 x 1mm	28 x 1,5mm	35 x 1,5mm	35 x 1,5mm
	ø scarico - ø drain	1" gas (33mm)	1" gas (33mm)	1" gas (33mm)	1" gas (33mm)



Caratteristiche tecniche

Technical features

Serie RDF / RDF Range		4,5 / 9 mm Passo alette / Fin spacing (Ø250)				
Modello Model	RDF	1250 1250ED	2250 2250ED	3250 3250ED	4250 4250ED	
Capacità ΔT 10 T. cella 2°C Capacity ΔT 10 Room T. 2°C	kW	1,16	2,35	3,91	5,34	
Portata d'aria Air flow	m ³ /h	483,0	1052,0	1621,0	2161,5	
Freccia d'aria Air throw	m	3	4	8	10	
Superficie totale Total surface	m ²	3,55	8,07	12,60	17,1	
Volume circuito evaporatore Unit cooler volume circuit	dm ³	1,1	2,42	3,73	5,04	
Motoventilatori Fan motors	n x Ømm	1x250	2x250	3x250	4x250	
Assorbimento motori (*) Motor power consumption	A	0,45	0,90	1,35	1,80	
	W	65	130	195	260	
Sbrinamento elettrico (*) Electrical defrost	W	800	1650	2500	3150	
Peso netto Net weight	vers. standard standard vers.	kg	11,5	18,0	27,0	34,0
	vers. ED ED vers.	kg	12,0	19,0	28,5	36,0

(*) Alimentazione elettrica: motoventilatori 230V-1-50Hz, sbrinamento elettrico predisposto per 400-3-50Hz
Power supply : fan motors (230V-1-50Hz), electrical defrost preset for 400V/3/50Hz

Serie RDF / RDF Range		Bassa velocità / Low speed (1070 Rpm)			3,5 mm Passo alette / Fin spacing (Ø350)	
Modello Model	RDF	23503 23503ED	33503 33503ED	43503 43503ED	53503 53503ED	
Capacità ΔT 10 T. cella 2°C Capacity ΔT 10 Room T. 2°C	kW	6,23	8,76	11,60	13,90	
Portata d'aria Air flow	m ³ /h	2847,5	4100,5	5354,0	6550,0	
Freccia d'aria Air throw	m	8	10	11	12	
Superficie totale Total surface	m ²	27,50	39,30	51,1	62,90	
Peso netto Net weight	vers. standard standard vers.	kg	38,5	54	65,4	79,7
	vers. ED ED vers.	kg	41	57,5	69,9	85,5

Serie RDF / RDF Range		Alta velocità / High speed (1360 Rpm)			3,5 mm Passo alette / Fin spacing (Ø350)	
Modello Model	RDF	23503 23503ED	33503 33503ED	43503 43503ED	53503 53503ED	
Capacità ΔT 10 T. cella 2°C Capacity ΔT 10 Room T. 2°C	kW	7,29	10,10	13,40	16,00	
Portata d'aria Air flow	m ³ /h	3816,5	5510,5	7062	8828,0	
Freccia d'aria Air throw	m	10	11	12	14	
Superficie totale Total surface	m ²	27,5	39,3	51,1	62,90	
Peso netto Net weight	vers. standard standard vers.	kg	38,5	54	65,4	79,7
	vers. ED ED vers.	kg	41	57,5	69,9	85,5

Technical features

Serie RDF / RDF Range		Bassa velocità / Low speed (1070 Rpm)		7 mm Passo alette / Fin spacing (Ø350)		
Modello	RDF	23507	33507	43507	53507	
Model		23507ED	33507ED	43507ED	53507ED	
Capacità $\Delta T 10$ T. cella 2°C Capacity $\Delta T 10$ Room T. 2°C	kW	4,32	5,67	7,88	9,02	
Portata d'aria Air flow	m ³ /h	3587,0	5295,0	6946,5	8540,5	
Freccia d'aria Air throw	m	9	11	12	14	
Superficie totale Total surface	m ²	14,60	20,90	27,10	33,40	
Peso netto Net weight	vers. standard standard vers.	kg	37,9	53,1	64,3	78,3
	vers. ED ED vers.	kg	40,4	56,6	68,8	84,1

Serie RDF / RDF Range		Alta velocità / High speed (1360 Rpm)		7 mm Passo alette / Fin spacing (Ø350)		
Modello	RDF	23507	33507	43507	53507	
Model		23507ED	33507ED	43507ED	53507ED	
Capacità $\Delta T 10$ T. cella 2°C Capacity $\Delta T 10$ Room T. 2°C	kW	4,82	6,24	8,77	9,86	
Portata d'aria Air flow	m ³ /h	4530,0	6688,0	8774,5	10968,0	
Freccia d'aria Air throw	m	10	12	14	15	
Superficie totale Total surface	m ²	14,60	20,90	27,10	33,40	
Peso netto Net weight	vers. standard standard vers.	kg	37,9	53,1	64,3	78,3
	vers. ED ED vers.	kg	40,4	56,6	68,8	84,1

Serie RDF / RDF Range		7 - 3,5 mm Passo alette / Fin spacing (Ø350)				
Modello	RDF	23503	33503	43503	53503	
Model		23503ED	33503ED	43503ED	53503ED	
		23507	33507	43507	53507	
		23507ED	33507ED	43507ED	53507ED	
Volume circuito evaporatore Unit cooler volume circuit	dm ³	5,27	7,48	9,67	11,90	
Motoventilatori Fan motors	n x Ømm	2x350	3x350	4x350	5x350	
Assorbimento motori (*) Motor power consumption	1070 rpm	A	1,28	1,92	2,56	3,20
		W	290	435	580	725
Assorbimento motori (*) Motor power consumption	1360 rpm	A	1,36	2,04	2,72	3,40
		W	306	459	612	765
Sbrinamento elettrico (*) Electrical defrost	W	2800	4096	5360	6160	

(*) Alimentazione elettrica: motoventilatori 230V-1-50Hz, sbrinamento elettrico predisposto per 400-3-50Hz
Power supply : fan motors (230V-1-50Hz), electrical defrost preset for 400V/3/50Hz



Scelta evaporatore

Model choice

Per una corretta scelta dell'evaporatore, utilizzare le tabelle "potenza frigorifera". Nelle tabelle vengono riportate le rese frigorifere calcolate per un range di temperatura cella (T_c) che varia in funzione del diametro ventola, del passo alette e della velocità del motoventilatore. Per ogni passo alette si consiglia la seguente applicazione: passo alette 3,5 mm, utilizzo ad una $T_c > 0 = +2^\circ\text{C}$; passo alette 4,5mm/ 9 mm, utilizzo ad una $T_c > 0 = -30^\circ\text{C}$; passo alette 7 mm, utilizzo ad una temperatura cella $> 0 = -35^\circ\text{C}$. Inoltre tali rese vengono calcolate in funzione di un ΔT (differenza tra la temperatura dell'aria in entrata e la temperatura di evaporazione del refrigerante) che va da 5°C a 10°C , utilizzando come refrigerante il gas R404A.

Impiegando altri refrigeranti, la capacità va moltiplicata per il fattore correttivo di seguito riportato: R134a=0,91; R507/R404A=1.

I parametri per la scelta dell'evaporatore sono: la temperatura della cella, il valore ΔT ed il carico termico. Nella colonna corrispondente alla temperatura cella desiderata, sceglieremo il modello che in corrispondenza del ΔT richiesto, avrà una resa uguale o superiore al carico termico.

For a correct choice of the unit cooler, use the "refrigerating output" tables.

In these tables are quoted the refrigerating capacities calculated for a cold room temperature (T_c) that changes according to the fan diameter, fin spacing and the motor fan speed of the unit cooler. For each different type of fin spacing we recommend to use the following applications: 3,5 mm fin spacing, $T_c > 0 = +2^\circ\text{C}$; 4,5mm/9mm fin spacing, $T_c > 0 = -30^\circ\text{C}$; 7 mm fin spacing, $T_c > 0 = -35^\circ\text{C}$.

Those capacities are calculated on the base of a ΔT value (i.e. difference between the inlet air temperature and the gas evaporating temperature) from 5 to 10, by using R404A gas.

In case of a different gas in use, the capacity is to be multiplied by the relevant corrective factor: R134a = 0,91; R507/R404A = 1.

The parameters valid for the unit cooler choice are the following ones: the cold room temperature, the ΔT value and the heat load.

In the column corresponding to the requested cold room temperature we will choose the model that, matching the line of the requested ΔT , will have a capacity equal or bigger than the heat load.

Dimensione imballi

Packages dimensions

Codice Code	Dimensione imballo evaporatore Evaporator package dimensions			
	A mm	B mm	H mm	Peso Weight Kg
RDF1250 ..	730	740	250	3,0
RDF2250 ..	1130	740	250	4,0
RDF3250 ..	1530	740	250	4,5
RDF4250 ...	1930	740	250	5,5
RDF2350 ...	1550	1010	435	13,0
RDF3350 ...	2000	1010	435	20,5
RDF4350 ...	2450	1010	435	22,0
RDF5350 ...	2900	1010	435	23,5

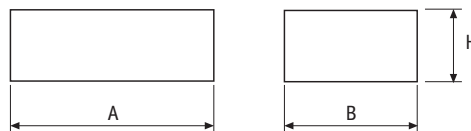

RDF1250 RDF1250ED

4,5 / 9 mm Passo alette / Fin spacing (Ø250)

		Tc	-30°C	-25°C	-20°C	-15°C	-10°C	-5°C	0°C	2°C	4°C	6°C	8°C	10°C	12°C	15°C
ΔT 10	UR/RH 76% kW		0,87	0,93	0,96	1,00	1,03	1,08	1,15	1,16	1,17	1,19	1,20	1,22	1,25	1,30
ΔT 9	UR/RH 79% kW		0,79	0,82	0,86	0,90	0,92	0,97	1,03	1,04	1,05	1,06	1,08	1,10	1,13	1,18
ΔT 8	UR/RH 82% kW		0,70	0,73	0,76	0,77	0,81	0,85	0,90	0,91	0,92	0,93	0,94	0,97	0,99	1,03
ΔT 7	UR/RH 85% kW		0,61	0,63	0,65	0,66	0,69	0,73	0,77	0,78	0,79	0,80	0,81	0,83	0,85	0,89
ΔT 6	UR/RH 89% kW		0,50	0,52	0,54	0,55	0,58	0,61	0,65	0,66	0,67	0,68	0,69	0,71	0,73	0,77
ΔT 5	UR/RH 93% kW		0,40	0,42	0,42	0,44	0,46	0,49	0,53	0,54	0,55	0,56	0,57	0,59	0,61	0,64

RDF2250 RDF2250ED

4,5 / 9 mm Passo alette / Fin spacing (Ø250)

		Tc	-30°C	-25°C	-20°C	-15°C	-10°C	-5°C	0°C	2°C	4°C	6°C	8°C	10°C	12°C	15°C
ΔT 10	UR/RH 76% kW		1,13	1,34	1,53	1,73	1,89	2,08	2,28	2,35	2,40	2,46	2,51	2,60	2,69	2,83
ΔT 9	UR/RH 79% kW		1,08	1,26	1,43	1,60	1,75	1,91	2,10	2,15	2,20	2,25	2,30	2,39	2,46	2,57
ΔT 8	UR/RH 82% kW		1,01	1,17	1,32	1,45	1,58	1,73	1,90	1,94	1,98	2,02	2,07	2,15	2,23	2,35
ΔT 7	UR/RH 85% kW		0,93	1,06	1,19	1,29	1,39	1,53	1,68	1,71	1,74	1,78	1,85	1,91	1,97	2,06
ΔT 6	UR/RH 89% kW		0,83	0,94	1,04	1,11	1,21	1,32	1,45	1,47	1,50	1,53	1,60	1,66	1,72	1,81
ΔT 5	UR/RH 93% kW		0,72	0,81	0,88	0,94	1,02	1,11	1,22	1,24	1,26	1,31	1,37	1,42	1,48	1,57

RDF3250 RDF3250ED

4,5 / 9 mm Passo alette / Fin spacing (Ø250)

		Tc	-30°C	-25°C	-20°C	-15°C	-10°C	-5°C	0°C	2°C	4°C	6°C	8°C	10°C	12°C	15°C
ΔT 10	UR/RH 76% kW		2,29	2,60	2,85	3,06	3,30	3,55	3,84	3,91	3,99	4,05	4,12	4,22	4,36	4,57
ΔT 9	UR/RH 79% kW		2,14	2,38	2,62	2,80	3,00	3,22	3,48	3,55	3,61	3,66	3,72	3,85	3,96	4,13
ΔT 8	UR/RH 82% kW		1,97	2,17	2,34	2,51	2,68	2,88	3,11	3,16	3,21	3,25	3,32	3,44	3,54	3,69
ΔT 7	UR/RH 85% kW		1,78	1,93	2,06	2,20	2,35	2,52	2,72	2,76	2,79	2,85	2,92	3,01	3,11	3,26
ΔT 6	UR/RH 89% kW		1,54	1,67	1,77	1,89	2,01	2,16	2,35	2,39	2,44	2,49	2,54	2,63	2,72	2,86
ΔT 5	UR/RH 93% kW		1,29	1,37	1,46	1,55	1,66	1,79	1,95	1,98	2,02	2,07	2,14	2,22	2,31	2,45

RDF4250 RDF4250ED

4,5 / 9 mm Passo alette / Fin spacing (Ø250)

		Tc	-30°C	-25°C	-20°C	-15°C	-10°C	-5°C	0°C	2°C	4°C	6°C	8°C	10°C	12°C	15°C
ΔT 10	UR/RH 76% kW		3,36	3,75	4,09	4,35	4,58	4,88	5,25	5,34	5,43	5,51	5,59	5,71	5,90	6,19
ΔT 9	UR/RH 79% kW		3,12	3,45	3,74	3,89	4,14	4,42	4,75	4,82	4,89	4,96	5,03	5,20	5,35	5,58
ΔT 8	UR/RH 82% kW		2,85	3,12	3,31	3,47	3,68	3,92	4,22	4,29	4,34	4,39	4,47	4,63	4,77	4,98
ΔT 7	UR/RH 85% kW		2,54	2,75	2,90	3,03	3,21	3,42	3,68	3,74	3,80	3,85	3,93	4,04	4,16	4,34
ΔT 6	UR/RH 89% kW		2,20	2,36	2,44	2,58	2,73	2,91	3,16	3,23	3,26	3,32	3,40	3,51	3,63	3,81
ΔT 5	UR/RH 93% kW		1,83	1,92	1,99	2,10	2,23	2,40	2,62	2,67	2,71	2,76	2,86	2,96	3,07	3,24

Tc = temperatura cella / cold room temperature

**R404A****Potenza frigorifera***Refrigerating output***Bassa velocità / Low speed (1070 Rpm)**

RDF23503 RDF23503ED			3,5 mm Passo alette / Fin spacing (Ø350)								
Tc			-5°C (*)	0°C (*)	2°C	4°C	6°C	8°C	10°C	12°C	15°C
ΔT 10	UR/RH 76%	kW	5,89	6,19	6,23	6,25	6,28	6,30	6,34	6,50	6,74
ΔT 9	UR/RH 79%	kW	5,22	5,48	5,50	5,52	5,56	5,61	5,67	5,75	5,87
ΔT 8	UR/RH 82%	kW	4,48	4,71	4,73	4,76	4,79	4,82	4,85	4,93	5,05
ΔT 7	UR/RH 85%	kW	3,74	3,93	3,94	3,95	3,97	3,99	4,05	4,11	4,20
ΔT 6	UR/RH 89%	kW	3,08	3,25	3,27	3,29	3,31	3,33	3,39	3,45	3,54
ΔT 5	UR/RH 93%	kW	2,41	2,56	2,57	2,58	2,60	2,66	2,72	2,78	2,87

Bassa velocità / Low speed (1070 Rpm)

RDF33503 RDF33503ED			3,5 mm Passo alette / Fin spacing (Ø350)								
Tc			-5°C (*)	0°C (*)	2°C	4°C	6°C	8°C	10°C	12°C	15°C
ΔT 10	UR/RH 76%	kW	8,08	8,64	8,76	8,86	8,96	9,03	9,21	9,45	9,81
ΔT 9	UR/RH 79%	kW	7,28	7,78	7,87	7,92	8,01	8,16	8,31	8,47	8,71
ΔT 8	UR/RH 82%	kW	6,44	6,86	6,92	6,96	7,04	7,16	7,31	7,44	7,64
ΔT 7	UR/RH 85%	kW	5,55	5,90	5,93	5,98	6,06	6,14	6,26	6,38	6,56
ΔT 6	UR/RH 89%	kW	4,66	4,97	5,00	5,05	5,12	5,21	5,32	5,44	5,62
ΔT 5	UR/RH 93%	kW	3,75	4,01	4,05	4,10	4,15	4,25	4,36	4,48	4,66

Bassa velocità / Low speed (1070 Rpm)

RDF43503 RDF43503ED			3,5 mm Passo alette / Fin spacing (Ø350)								
Tc			-5°C (*)	0°C (*)	2°C	4°C	6°C	8°C	10°C	12°C	15°C
ΔT 10	UR/RH 76%	kW	10,90	11,50	11,60	11,70	11,80	11,90	12,00	12,30	12,75
ΔT 9	UR/RH 79%	kW	9,60	10,20	10,30	10,40	10,50	10,60	10,70	10,90	11,20
ΔT 8	UR/RH 82%	kW	8,42	8,91	8,95	9,00	9,10	9,21	9,34	9,50	9,74
ΔT 7	UR/RH 85%	kW	7,18	7,60	7,65	7,70	7,75	7,81	7,95	8,08	8,28
ΔT 6	UR/RH 89%	kW	5,99	6,35	6,39	6,44	6,50	6,58	6,71	6,85	7,06
ΔT 5	UR/RH 93%	kW	4,76	5,07	5,11	5,15	5,20	5,33	5,44	5,58	5,79

Bassa velocità / Low speed (1070 Rpm)

RDF53503 RDF53503ED			3,5 mm Passo alette / Fin spacing (Ø350)								
Tc			-5°C (*)	0°C (*)	2°C	4°C	6°C	8°C	10°C	12°C	15°C
ΔT 10	UR/RH 76%	kW	12,70	13,70	13,90	14,10	14,30	14,40	14,70	15,10	15,70
ΔT 9	UR/RH 79%	kW	11,50	12,30	12,50	12,60	12,80	12,90	13,30	13,50	13,80
ΔT 8	UR/RH 82%	kW	10,20	10,90	11,00	11,10	11,20	11,40	11,70	11,90	12,20
ΔT 7	UR/RH 85%	kW	8,83	9,43	9,48	9,60	9,72	9,86	10,10	10,30	10,60
ΔT 6	UR/RH 89%	kW	7,46	7,99	8,09	8,19	8,29	8,40	8,58	8,78	9,08
ΔT 5	UR/RH 93%	kW	6,02	6,47	6,55	6,63	6,71	6,88	7,06	7,26	7,56

Tc = temperatura cella / cold room temperature

(*) Per modelli passo alette 3,5 mm, si consiglia un utilizzo ad una Tc ≥ +2°C - For 3,5 mm fin spacing models we recommend to use the application Tc ≥ +2°C

Refrigerating output

Alta velocità / High Speed (1360 Rpm)

RDF23503 RDF23503ED			3,5 mm Passo alette / Fin spacing (Ø350)								
Tc			-5°C (*)	0°C (*)	2°C	4°C	6°C	8°C	10°C	12°C	15°C
ΔT 10	UR/RH 76%	kW	6,91	7,25	7,29	7,30	7,35	7,37	7,40	7,57	7,83
ΔT 9	UR/RH 79%	kW	6,12	6,42	6,43	6,45	6,48	6,53	6,60	6,69	6,83
ΔT 8	UR/RH 82%	kW	5,30	5,56	5,57	5,60	5,63	5,67	5,71	5,78	5,89
ΔT 7	UR/RH 85%	kW	4,39	4,59	4,60	4,61	4,62	4,64	4,70	4,76	4,85
ΔT 6	UR/RH 89%	kW	3,60	3,78	3,80	3,81	3,83	3,85	3,91	3,98	4,09
ΔT 5	UR/RH 93%	kW	2,81	2,96	2,97	2,98	3,00	3,06	3,12	3,19	3,30

Alta velocità / High Speed (1360 Rpm)

RDF33503 RDF33503ED			3,5 mm Passo alette / Fin spacing (Ø350)								
Tc			-5°C (*)	0°C (*)	2°C	4°C	6°C	8°C	10°C	12°C	15°C
ΔT 10	UR/RH 76%	kW	9,27	9,96	10,10	10,20	10,40	10,50	10,60	10,90	11,35
ΔT 9	UR/RH 79%	kW	8,37	8,97	9,07	9,16	9,26	9,42	9,60	9,79	10,08
ΔT 8	UR/RH 82%	kW	7,42	7,93	7,98	8,04	8,18	8,30	8,44	8,60	8,84
ΔT 7	UR/RH 85%	kW	6,40	6,82	6,88	6,96	7,03	7,09	7,22	7,35	7,55
ΔT 6	UR/RH 89%	kW	5,39	5,74	5,82	5,88	5,94	6,01	6,13	6,26	6,46
ΔT 5	UR/RH 93%	kW	4,33	4,63	4,67	4,72	4,78	4,89	5,01	5,13	5,31

Alta velocità / High Speed (1360 Rpm)

RDF43503 RDF43503ED			3,5 mm Passo alette / Fin spacing (Ø350)								
Tc			-5°C (*)	0°C (*)	2°C	4°C	6°C	8°C	10°C	12°C	15°C
ΔT 10	UR/RH 76%	kW	12,50	13,30	13,40	13,50	13,60	13,70	13,90	14,20	14,65
ΔT 9	UR/RH 79%	kW	11,20	11,90	12,00	12,10	12,20	12,30	12,50	12,70	13,00
ΔT 8	UR/RH 82%	kW	9,82	10,40	10,50	10,60	10,70	10,80	10,90	11,00	11,15
ΔT 7	UR/RH 85%	kW	8,38	8,84	8,88	8,93	9,00	9,08	9,22	9,37	9,60
ΔT 6	UR/RH 89%	kW	6,97	7,38	7,42	7,48	7,55	7,63	7,76	7,90	8,11
ΔT 5	UR/RH 93%	kW	5,52	5,87	5,91	5,95	6,01	6,14	6,28	6,42	6,63

Alta velocità / High Speed (1360 Rpm)

RDF53503 RDF53503ED			3,5 mm Passo alette / Fin spacing (Ø350)								
Tc			-5°C (*)	0°C (*)	2°C	4°C	6°C	8°C	10°C	12°C	15°C
ΔT 10	UR/RH 76%	kW	14,50	15,70	16,00	16,20	16,40	16,70	17,00	17,40	18,00
ΔT 9	UR/RH 79%	kW	13,20	14,20	14,40	14,50	14,70	14,90	15,30	15,60	16,05
ΔT 8	UR/RH 82%	kW	11,70	12,60	12,70	12,80	12,90	13,10	13,50	13,80	14,25
ΔT 7	UR/RH 85%	kW	10,20	10,90	11,00	11,10	11,20	11,40	11,60	11,80	12,10
ΔT 6	UR/RH 89%	kW	8,61	9,20	9,32	9,44	9,56	9,69	9,88	10,10	10,43
ΔT 5	UR/RH 93%	kW	6,95	7,46	7,54	7,63	7,72	7,92	8,11	8,32	8,64

Tc = temperatura cella / cold room temperature

(*) Per modelli passo alette 3,5 mm, si consiglia un utilizzo ad una Tc ≥ +2°C - For 3,5 mm fin spacing models we recommend to use the application Tc ≥ +2°C

**R404A****Potenza frigorifera***Refrigerating output***Bassa velocità / Low speed (1070 Rpm)**

RDF23507 RDF23507ED			7 mm Passo alette / Fin spacing (Ø350)									
Tc			-35°C	-30°C	-25°C	-20°C	-15°C	-10°C	-5°C	0°C	2°C	4°C
ΔT 10	UR/RH 76%	kW	3,54	3,85	4,11	4,32	4,45	4,62	4,81	5,03	5,05	5,06
ΔT 9	UR/RH 79%	kW	3,22	3,47	3,68	3,80	3,94	4,05	4,21	4,41	4,42	4,44
ΔT 8	UR/RH 82%	kW	2,86	3,06	3,19	3,31	3,43	3,51	3,65	3,82	3,84	3,86
ΔT 7	UR/RH 85%	kW	2,49	2,63	2,72	2,80	2,90	2,96	3,08	3,23	3,24	3,25
ΔT 6	UR/RH 89%	kW	2,07	2,16	2,23	2,30	2,35	2,43	2,54	2,67	2,68	2,70
ΔT 5	UR/RH 93%	kW	1,63	1,69	1,74	1,77	1,83	1,90	1,99	2,12	2,13	2,14

Bassa velocità / Low speed (1070 Rpm)

RDF33507 RDF33507ED			7 mm Passo alette / Fin spacing (Ø350)									
Tc			-35°C	-30°C	-25°C	-20°C	-15°C	-10°C	-5°C	0°C	2°C	4°C
ΔT 10	UR/RH 76%	kW	4,02	4,62	5,19	5,67	6,10	6,49	6,88	7,29	7,37	7,42
ΔT 9	UR/RH 79%	kW	3,75	4,28	4,74	5,15	5,50	5,83	6,16	6,53	6,58	6,62
ΔT 8	UR/RH 82%	kW	3,44	3,87	4,26	4,58	4,87	5,14	5,42	5,74	5,77	5,83
ΔT 7	UR/RH 85%	kW	3,08	3,43	3,73	3,98	4,20	4,41	4,65	4,92	4,95	5,00
ΔT 6	UR/RH 89%	kW	2,68	2,94	3,16	3,35	3,51	3,69	3,89	4,14	4,17	4,20
ΔT 5	UR/RH 93%	kW	2,22	2,40	2,55	2,68	2,79	2,93	3,10	3,31	3,34	3,37

Bassa velocità / Low speed (1070 Rpm)

RDF43507 RDF43507ED			7 mm Passo alette / Fin spacing (Ø350)									
Tc			-35°C	-30°C	-25°C	-20°C	-15°C	-10°C	-5°C	0°C	2°C	4°C
ΔT 10	UR/RH 76%	kW	5,93	6,67	7,33	7,88	8,35	8,70	9,14	9,62	9,69	9,74
ΔT 9	UR/RH 79%	kW	5,48	6,11	6,65	7,09	7,47	7,76	8,14	8,57	8,61	8,63
ΔT 8	UR/RH 82%	kW	4,97	5,48	5,90	6,25	6,50	6,79	7,10	7,48	7,53	7,59
ΔT 7	UR/RH 85%	kW	4,39	4,78	5,11	5,36	5,50	5,78	6,05	6,37	6,39	6,43
ΔT 6	UR/RH 89%	kW	3,75	4,04	4,27	4,42	4,60	4,80	5,03	5,32	5,36	5,40
ΔT 5	UR/RH 93%	kW	3,05	3,23	3,39	3,49	3,63	3,79	4,00	4,25	4,28	4,32

Bassa velocità / Low speed (1070 Rpm)

RDF53507 RDF53507ED			7 mm Passo alette / Fin spacing (Ø350)									
Tc			-35°C	-30°C	-25°C	-20°C	-15°C	-10°C	-5°C	0°C	2°C	4°C
ΔT 10	UR/RH 76%	kW	6,20	7,20	8,16	9,02	9,70	10,40	11,00	11,70	11,80	11,90
ΔT 9	UR/RH 79%	kW	5,80	6,69	7,50	8,23	8,79	9,29	9,85	10,50	10,60	10,70
ΔT 8	UR/RH 82%	kW	5,36	6,10	6,78	7,29	7,80	8,20	8,68	9,23	9,28	9,33
ΔT 7	UR/RH 85%	kW	4,83	5,43	5,96	6,36	6,76	7,08	7,47	7,93	8,00	8,07
ΔT 6	UR/RH 89%	kW	4,22	4,69	5,04	5,38	5,64	5,94	6,28	6,69	6,76	6,83
ΔT 5	UR/RH 93%	kW	3,52	3,82	4,10	4,31	4,52	4,77	5,06	5,41	5,47	5,53

Tc = temperatura cella / cold room temperature

Refrigerating output

Alta velocità / High speed (1360 Rpm)

RDF23507 RDF23507ED			7 mm Passo alette / Fin spacing (Ø350)									
Tc			-35°C	-30°C	-25°C	-20°C	-15°C	-10°C	-5°C	0°C	2°C	4°C
ΔT 10	UR/RH 76%	kW	3,84	4,23	4,56	4,82	5,05	5,26	5,47	5,71	5,73	5,74
ΔT 9	UR/RH 79%	kW	3,50	3,83	4,09	4,30	4,48	4,63	4,79	5,00	5,01	5,03
ΔT 8	UR/RH 82%	kW	3,13	3,39	3,58	3,75	3,88	3,99	4,15	4,33	4,34	4,36
ΔT 7	UR/RH 85%	kW	2,73	2,91	3,06	3,18	3,28	3,37	3,50	3,65	3,66	3,67
ΔT 6	UR/RH 89%	kW	2,29	2,42	2,52	2,60	2,66	2,76	2,87	3,02	3,03	3,04
ΔT 5	UR/RH 93%	kW	1,81	1,90	1,96	2,01	2,07	2,15	2,25	2,38	2,39	2,40

Alta velocità / High speed (1360 Rpm)

RDF33507 RDF33507ED			7 mm Passo alette / Fin spacing (Ø350)									
Tc			-35°C	-30°C	-25°C	-20°C	-15°C	-10°C	-5°C	0°C	2°C	4°C
ΔT 10	UR/RH 76%	kW	4,26	4,96	5,63	6,24	6,77	7,26	7,72	8,20	8,28	8,34
ΔT 9	UR/RH 79%	kW	3,99	4,61	5,18	5,69	6,13	6,54	6,93	7,35	7,41	7,45
ΔT 8	UR/RH 82%	kW	3,68	4,21	4,68	5,08	5,44	5,77	6,10	6,46	6,49	6,52
ΔT 7	UR/RH 85%	kW	3,32	3,74	4,11	4,42	4,70	4,97	5,23	5,53	5,56	5,61
ΔT 6	UR/RH 89%	kW	2,90	3,22	3,50	3,73	3,94	4,12	4,35	4,62	4,65	4,69
ΔT 5	UR/RH 93%	kW	2,41	2,64	2,83	3,00	3,12	3,29	3,49	3,72	3,75	3,78

Alta velocità / High speed (1360 Rpm)

RDF43507 RDF43507ED			7 mm Passo alette / Fin spacing (Ø350)									
Tc			-35°C	-30°C	-25°C	-20°C	-15°C	-10°C	-5°C	0°C	2°C	4°C
ΔT 10	UR/RH 76%	kW	6,35	7,25	8,06	8,77	9,35	9,81	10,30	10,90	11,00	11,10
ΔT 9	UR/RH 79%	kW	5,90	6,66	7,34	7,91	8,39	8,76	9,20	9,68	9,72	9,75
ΔT 8	UR/RH 82%	kW	5,38	6,01	6,54	6,99	7,31	7,67	8,04	8,45	8,51	8,57
ΔT 7	UR/RH 85%	kW	4,77	5,26	5,67	6,01	6,26	6,54	6,84	7,19	7,22	7,25
ΔT 6	UR/RH 89%	kW	4,11	4,47	4,76	4,97	5,19	5,42	5,68	5,99	6,03	6,07
ΔT 5	UR/RH 93%	kW	3,34	3,59	3,76	3,93	4,09	4,27	4,50	4,78	4,81	4,84

Alta velocità / High speed (1360 Rpm)

RDF53507 RDF53507ED			7 mm Passo alette / Fin spacing (Ø350)									
Tc			-35°C	-30°C	-25°C	-20°C	-15°C	-10°C	-5°C	0°C	2°C	4°C
ΔT 10	UR/RH 76%	kW	6,53	7,68	8,82	9,86	10,70	11,50	12,30	13,20	13,30	13,40
ΔT 9	UR/RH 79%	kW	6,15	7,17	8,15	9,02	9,74	10,40	11,10	11,80	11,90	12,00
ΔT 8	UR/RH 82%	kW	5,69	6,57	7,39	8,05	8,68	9,25	9,82	10,40	10,50	10,60
ΔT 7	UR/RH 85%	kW	5,16	5,89	6,50	7,05	7,54	8,00	8,46	8,97	9,05	9,13
ΔT 6	UR/RH 89%	kW	4,55	5,08	5,56	5,97	6,36	6,72	7,12	7,57	7,65	7,73
ΔT 5	UR/RH 93%	kW	3,80	4,20	4,54	4,83	5,11	5,39	5,72	6,11	6,17	6,24

Tc = temperatura cella / cold room temperature

LETTURA CODICE / MODEL DESIGNATION

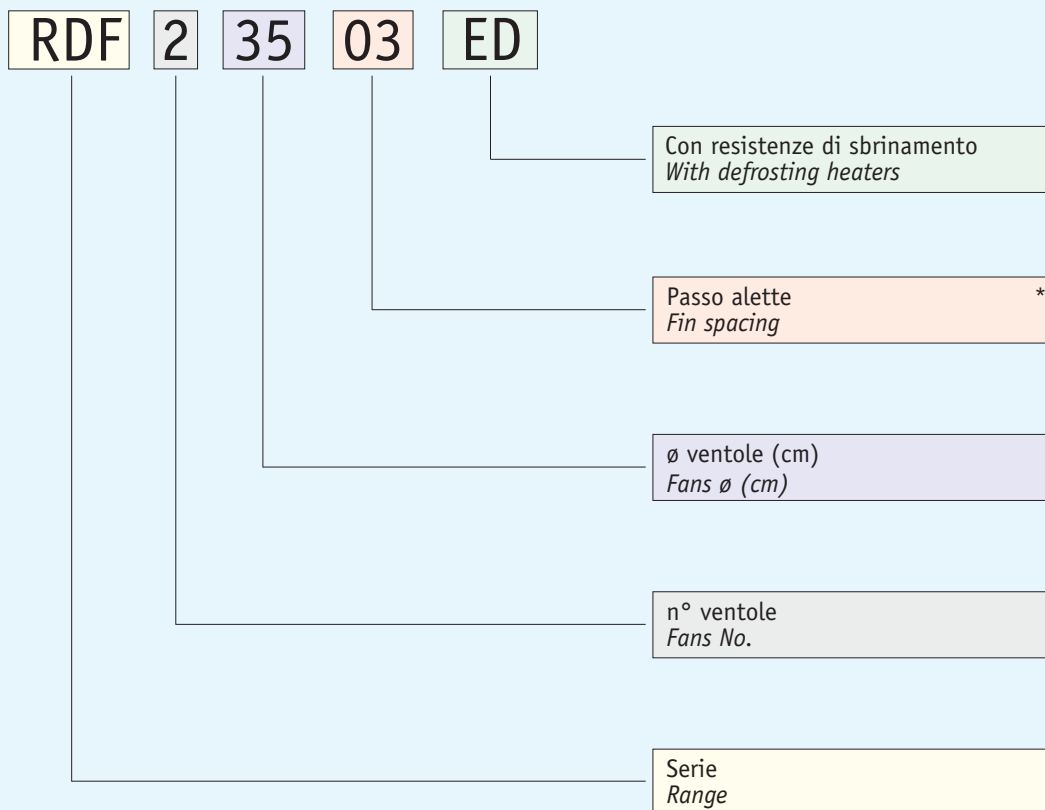

(*) Per i modelli con ventola 250mm il passo alette non viene indicato nel codice perché sempre uguale per tutti i modelli (=4,5/9mm)
For models having 250mm Ø fan, the fin spacing is not mentioned in the code as it is the same for all models (=4,5/9mm)

Per ulteriori informazioni, contattare il nostro ufficio tecnico / For further information, please contact our technical dept

Descrizione, dati tecnici e illustrazioni sono indicativi e non vincolanti. La Rivacold si riserva il diritto di modificare per intero o in parte le specifiche descritte nella presente documentazione senza preavviso e a beneficio della continuità produttiva, di utilizzare produttori alternativi di componenti previsti nel progetto

Descriptions, technical data and pictures are to be considered as a guide and not binding. Rivacold reserves the right to change in whole or part, the specification detailed in this documentation without prior notice and, when necessary to achieve continuous production, to use alternative manufactures of components for the design accomplishment

Rivacold unit coolers

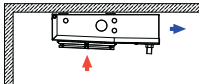
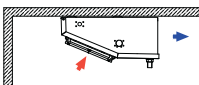
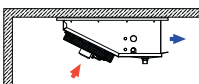
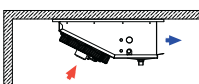
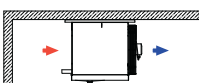
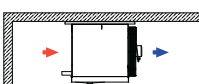
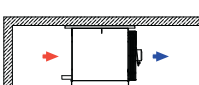
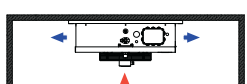
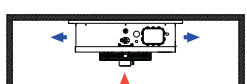
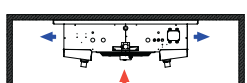
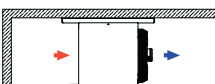
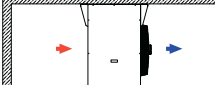
Serie Range	Potenza / Capacity								Ventole Fans	
	1000W	2000W	4000W	8000W	16000W	32000W	64000W	128000W		
RS	109 - 2640 w									1 - 4
RSV	350 - 2930 w									1 - 2
RSI 250	440 - 5380 w									1 - 4
RSI 350	1580 - 11600 w									2 - 4
RC	602 - 7380 w									1 - 4
RCS	410 - 8120 w									1 - 4
RCMR	1840 - 22400 w									1 - 4
RDF 250	400 - 5710 w									1 - 4
RDF 350	1630 - 17400 w									2 - 5
RDFR 500	3260 - 82050 w									1 - 4
RCBR 500	2950 - 59800 w									1 - 4
RCBR 630	3180 - 71200 w									1 - 4

RIVACOLD s.r.l.

Costruzione Gruppi Frigoriferi e Accessori

Via Sicilia, 7 - 61020 Montecchio PU - Italy

Tel. +39.0721.919911 - Fax +39.0721.490015

www.rivacold.com / info@rivacold.com



A Member of **RIVACOLD GROUP** 